

REMER

RUBINETTERIE

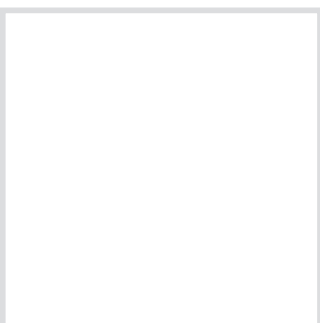
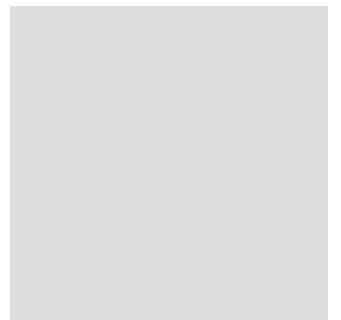
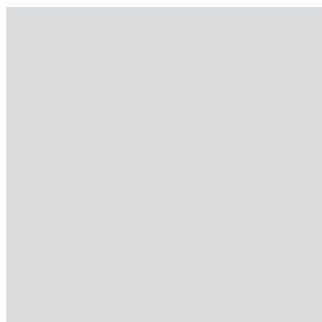
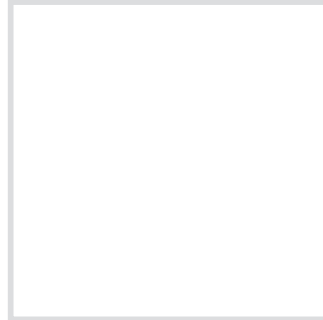

MADE IN ITALY 

LISTINO PREZZI MINUTERIA

MINUTERY PRICE LIST

18-19

REMER

RUBINETTERIE

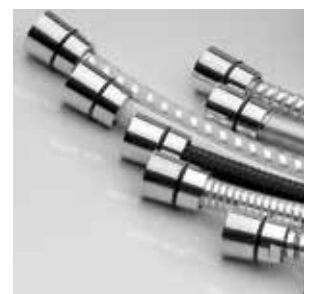
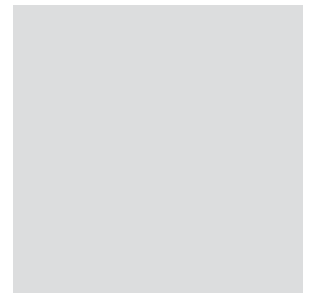
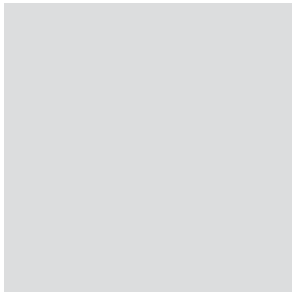
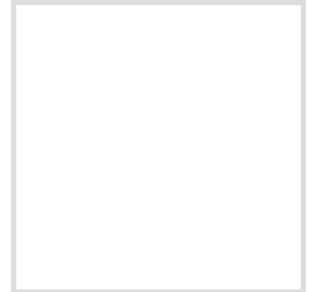

MADE IN ITALY 

LISTINO PREZZI MINUTERIA

MINUTERY PRICE LIST

18-19

INDICE

L'AZIENDA THE COMPANY



IL GRUPPO - THE GROUP	PAG. 004	INGENEREENG 1 HIGH TECH PRODUCTION	PAG. 113
LA NOSTRA FORZA - OUR STRENGTH	PAG. 006	INGENEREENG 2 HIGH TECH PRODUCTION	PAG. 115
TECNOLOGIE ED INVESTIMENTI TECHNOLOGY AND INVESTMENT	PAG. 112	IMPIANTI DI PULITURA POLISHING DEPARTMENTS	PAG. 0118

FLESSIBILI FLEXIBLE HOSES

PAG. 008



FLESSIBILI DN6 ACCIAIO INOX DN6 FLEXIBLES STAINLESS STEEL	PAG. 010	FLESSIBILI DN13 ACCIAIO INOX DN13 FLEXIBLES STAINLESS STEEL	PAG. 022
FLESSIBILI DN 6 ALLUMINIO DN6 FLEXIBLES ALUMINIUM	PAG. 011	FLESSIBILI ANTIVIBRANTI ANTI-VIBRATION FLEXIBLES	PAG. 024
FLESSIBILI DN8 ACCIAIO INOX DN8 FLEXIBLES STAINLESS STEEL	PAG. 012	FLESSIBILI ANTIVIBRANTI INOX STAINLESS STEEL ANTI-VIBRATION FLEXIBLES	PAG. 026
FLESSIBILI DN8 ALLUMINIO DN8 FLEXIBLES ALUMINIUM	PAG. 014	TUBI DI RAME - COPPER TUBES	PAG. 028
FLESSIBILI DN10 ACCIAIO INOX DN10 FLEXIBLES STAINLESS STEEL	PAG. 016	ADATTATORI PER FLESSIBILI FLEXIBLE HOSES ADAPTER	PAG. 028
FLESSIBILI DN10 ALLUMINIO DN10 FLEXIBLES ALUMINIUM	PAG. 018	RACCORDI E NIPPLES CONNECTIONS AND NIPPLES	PAG. 029
FLESSIBILI DN10 PVC DN10 FLEXIBLES PVC	PAG. 020		

MINUTERIA MINUTERY

PAG. 030



RUBINETTI SOTTOLAVABO C.P. BRASS ANGLE VALVE	PAG. 032	PASSO RAPIDO - FLUSHING VALVES	PAG. 036
ROSETTE - WALL FLANGES	PAG. 034	GALLEGGIANTI - FLUSHING VALVES	PAG. 036
CANOTTI, RACCORDI E TUBI TUBES AND CONNECTORS	PAG. 035	RUBINETTI - TAPS	PAG. 037
		ACCESSORI PER LAVATRICE WASHING MACHINE ACCESSORIES	PAG. 040

VALVOLE VALVES

PAG. 042



SERIE SEVEN - SEVEN SERIE	PAG. 044	SERIE REDUCE FLOW - REDUCE FLOW SERIE	PAG. 052
SERIE RR - RR SERIE	PAG. 046	VALVOLE - VALVES	PAG. 054
SERIE FULL FLOW - FULL FLOW SERIE	PAG. 048	SERIE YELLOW - YELLOW SERIE	PAG. 058
SERIE STANDARD - STANDARD SERIE	PAG. 050		



INDEX

L'AZIENDA THE COMPANY



TAGLIO LASTRE - PLATE CUTTING	PAG. 121
IMPIANTO DI CROMATURA CHROME-PLATING DEPARTMENT	PAG. 121
TRECCIATURA TUBI FLEXIBLE HOSES BRAIDING	PAG. 122
STAMPAGGIO MATERIALI PLASTICI INJECTION PLASTIC MATERIAL PRESSING	PAG. 123

RICERCA E SVILUPPO RESEARCH AND DEVELOPMENT	PAG. 124
CERTIFICATI - CERTIFICATES	PAG. 015
CONDIZIONI GENERALI DI VENDITA SALES CONDITIONS	PAG. 128

RACCORDERIA FITTINGS

PAG. 060



RACCORDI IN OTTONE - BRASS FITTINGS	PAG. 063
VITI DOPPIE - DOUBLE NIPPLES	PAG. 066
PORTAGOMMA - HOSE HOLDER	PAG. 066
RACCORDI - FITTINGS	PAG. 067
RACCORDI IN ACCIAIO ZINCATO GALVANIZED FITTINGS	PAG. 067
SERIE 495 - 495 SERIE:	PAG. 068
TUBO MULTISTRATO RR PEX MULTILAYER PIPE RR PEX	PAG. 068

ANALISI DEL TUBO MULTISTRATO RR PEX ANALYSIS OF THE MULTILAYER PIPE RR PEX	PAG. 069
SERIE 490 - 490 SERIE:	PAG. 070
ACCESSORI PER RADIATORI RADIATOR ACCESSORIES	PAG. 071
ACCESSORI PER TUBI ACCESSORIES FOR PIPES	PAG. 073

ACCESSORI ACCESSORIES

PAG. 074



ACCESSORI PER LAVABO WASH BASIN ACCESSORIES	PAG. 076
CARTUCCE - CARTRIDGES	PAG. 076
DEVIATORI - DIVERTERS	PAG. 078
PROLUNGHE - EXTENSIONS	PAG. 078
VITONI - HEADVALVES	PAG. 079
LINEA RISPARMIO IDRICO WATER SAVING LINE	PAG. 080
RIDUZIONI - REDUCTION	PAG. 081
AERATORI - AERATORS	PAG. 082
ECCENTRICI - ECCENTRICS	PAG. 083
COLONNE BORDO VASCA VERTICAL CONNECTIONS FOR BATH MIXER	PAG. 083
BOCCHIE - SPOUTS	PAG. 084
SUPPORTI DOCCIA - HAND SHOWER SUPPORTS	PAG. 085
SCARICHI - WASTES	PAG. 085
ACCESSORI PER LAVABO WASH BASIN ACCESSORIES	PAG. 086
ACCESSORI PER LAVELLO - SINK ACCESSORIES	PAG. 086

ACCESSORI PER WC ED ORINatoi WC AND ORINALS ACCESSORIES	PAG. 087
ACCESSORI PER DOCCIA - SHOWER ACCESSORIES	PAG. 089
- PILETTE SIFONATE - SIPHON DRAINS	PAG. 089
- CANALINE SIFONATE RETTANGOLARI RECTANGULARS FLOOR DRAINS	PAG. 089
- COPERTURA A PAVIMENTO IN ACCIAIO INOX STAINLESS STEEL FLOOR DRAINS	PAG. 089
- SIFONI ANTISCARAFAGGIO ANTI COCKROACH-INSECT TRAP	PAG. 090
SCARICHI AUTOMATICI - POP-UP WASTES	PAG. 090
SCARICHI AUTOMATICI CLICK-CLACK AUTOMATIC CLICK-CLACK POP-UP WASTES	PAG. 091
SIFONI - TRAPS	PAG. 092
- SIFONI SALVASPAZIO SAVE-SPACING SIPHONS	PAG. 093
COLONNE DI SCARICO - BATH WASTES	PAG. 094
ACCESSORI PER SCALDABAGNO WATER HEATER ACCESSORIES	PAG. 095

COMPONENTI PLASTICI PLASTIC COMPONENTS

PAG. 096



REMER

LA FORZA DI UN GRANDE GRUPPO
THE STRENGTH OF A BIG GROUP

- Pulitura, Controllo qualità, Pre-assemblaggio, Stampaggio plastico, Logistica.
Polishing department, Test department, Pre-assembly department, Injection plastic pressing department, Logistic department.
- Sede operativa e Ufficio amministrativo.
- ENGINEEREENG 2
produzione high-tech
high-tech production.
- REMER STORE
- ENGINEEREENG 1
produzione high-tech
high-tech production.
-  **FLEXITALY**
produzione flessibili
flexible hoses production.



Cassano d'Adda (MI) - Italy
Lat: 45° 31' 37" N Long: 9° 30' 11" E

sede storica
hystorical factory



REMER sede operativa e uffici amministrativi.

REMER main factory and offices.



REMER ENGINEERING 1 produzione high-tech, R&D.

REMER ENGINEERING 1 high-tech production, R&D.



REMER ENGINEERING 2 produzione high-tech.

REMER ENGINEERING 2 high-tech production.



REMER Pulitura. Controllo qualità, Pre-assemblaggio, Stampaggio plastico, Logistica.

REMER Polishing department, Test department, Pre-assembly department, Injection plastic pressing department, logistic center.



FLEXITALY: produzione flessibili.

FLEXITALY: production of flexibles.

LA NOSTRA FORZA OUR STRENGTH

LA NOSTRA FORZA È DETERMINATA
DA DIVERSI FATTORI:

OUR STRENGTH IS DETERMINED
BY MANY FACTORS:

- Produzione interna di articoli fusi, stampati, da barra, da lastra e da tubo di ottone
- Produzione interna di componenti in plastica
- 100% prodotto testato e garantito
- Linee di assemblaggio automatiche
- Tutta la produzione, l'assemblaggio e la logistica automatizzata, robotizzata e computerizzata
- Rapidità di consegna e disponibilità costante del prodotto
- Produzione interna di svariate componentistiche incluse cartucce, vitoni, flessibili, deviatori e molto altro
- 100% ciclo di produzione interno incluse pulitura e cromatura e verniciatura
- 100% materia prima di qualità per un prodotto conforme
- Circa 100 postazioni in radio frequenza
- Produzione interna di packaging
- Assistenza vendite e post vendita con servizio di qualità

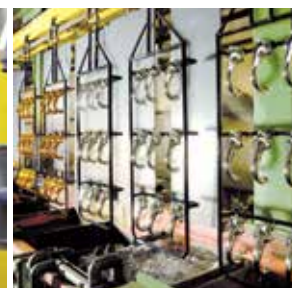

LE NOSTRE CERTIFICAZIONI:

Remer Rubinetterie S.p.A. è un'azienda certificata UNI EN ISO 9001:2008 sistema di gestione qualità aziendale e UNI EN ISO 14001: 2004 per l'impatto ambientale.

OUR CERTIFICATIONS:

Remer Rubinetterie S.p.A. is a UNI EN ISO 9001:2008 certified factory for the quality system and UNI EN ISO 14001: 2004 for environmental impact.



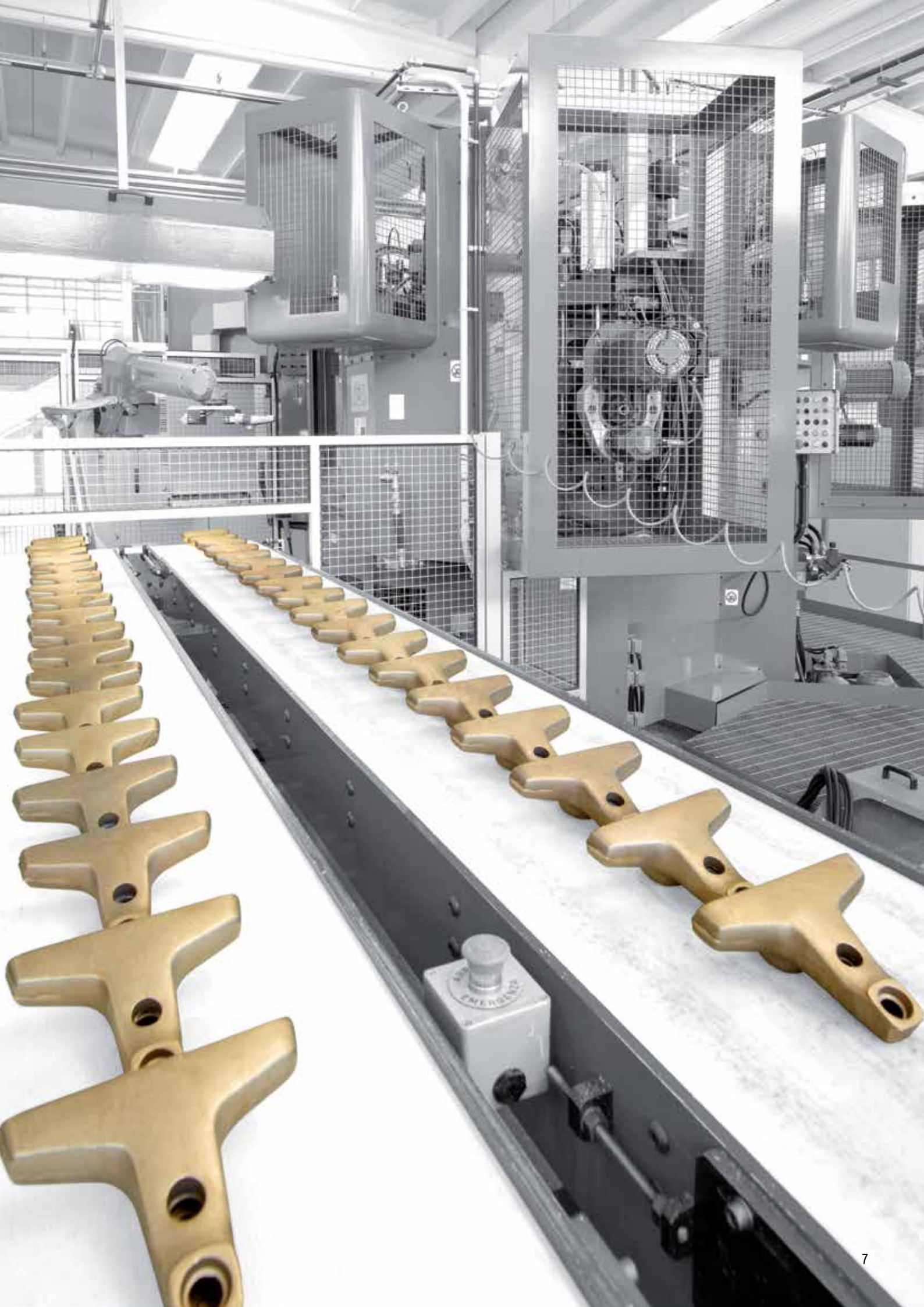



FLESSIBILI FLEXIBLE HOSES



FLESSIBILI - FLEXIBLE HOSES



DN6

DN8

DN10

DN13

ANTIVIBRANTI
ANTI-VIBRATIONS

TUBI DI RAME E ACCESSORI
COPPER TUBES & ACCESSORIES

FLESSIBILI DN 6 ACCIAIO INOX

FLESSIBILI PER RUBINETTERIA

DN 6 FLEXIBLES STAINLESS STEEL

FLEXIBLE HOSES FOR FAUCETS



DATI TECNICI - TECHNICAL DATA:

Tubo flessibile trecciato made in Italy in acciaio Inox AISI 304 con interno in gomma alimentare EPDM utilizzato per il collegamento tra la rete idrica e la rubinetteria sanitaria. Grazie alle dimensioni molto ridotte e alla pressatura su tutta la lunghezza della bussola, questo flessibile favorisce l'installazione su rubinetterie di qualsiasi design, specialmente quelle con un design molto minimale con degli spazi tecnici ridotti o poco accessibili. Tutti i flessibili sono raccordati con macchine automatiche ed il risultato è l'assoluta precisione di ogni pezzo prodotto per una garanzia di totale qualità.

Made in Italy braided hose in AISI 304 stainless steel with internal in non-toxic EPDM rubber, used for the connection between the water mains and the sanitary fittings. Thanks to the very small size and the pressing all along the entire length of the sleeve, this hose facilitates the installation on faucets of any design, especially on those with a very minimal design with reduced engineering spaces or not very accessible. All the hoses are produced with automatic machines and the result is the absolute precision of each produced piece for a total quality guarantee.

APPLICAZIONI APPLICATIONS:



MATERIALI - MATERIALS:

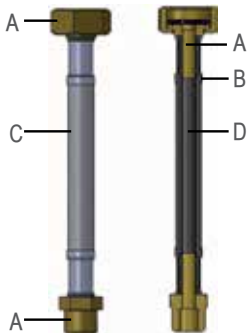

RACCORDI - FITTINGS:

A) Ottone CW614N e CW617N nichelato o giallo
Brass CW614N and CW617N nickel plated or yellow

BUSSOLE - SLEEVES:

B) Acciaio INOX AISI 304
Stainless steel AISI 304

TUBO - HOSE:

C) Treccia 6 fili in acciaio INOX AISI 304
6 Wires Braid in steel INOX AISI 304
D) Tubo interno: gomma EPDM atossico
Internal pipe EPDM rubber, atoxic

CRATTERISTICHE - FEATURES:



TEMPERATURA INSTALLAZIONE - INSTALLATION TEMPERATURE:

Da -5°C a +90°C - From -5°C to +90°C



PRESSIONE D'ESERCIZIO - WORKING PRESSURE:

10 BAR



PORTATA A 3 BAR - FLOW RATE AT 3 BAR:

19 lit/min



TEMPERATURA D'IMPIEGO - WORKING TEMPERATURE:

-5°C - +90°C



FORO MINIMO PASSAGGIO D'ACQUA - FITTING INNER DIAMETER:

4,7 mm



RAGGIO CURVATURA MINIMO - MINIMUM BENDING RADIUS:

25 mm



Ø INTERNO - INNER Ø:

Ø 6 mm



Ø ESTERNO - OUTER Ø:

Ø 10 mm

108P 12F

Flessibile in Acciaio Inox AISI 304 - DN6 M10x1 - 1/2°F.
Stainless Steel Flexible hose AISI 304 - DN6 M10x1 - 1/2°F.

cm	20	25	30	35	40	45	50	60	80	100
€	2,40	2,60	2,70	2,80	2,90	3,10	3,20	3,40	3,90	4,40

108LP 12F

Flessibile in Acciaio Inox AISI 304 - DN6 ML10x1 - 1/2°F.
Stainless Steel Flexible hose AISI 304 - DN6 ML10x1 - 1/2°F.

cm	20	25	30	35	40	45	50	60	80	100
€	3,00	3,10	3,30	3,40	3,50	3,60	3,80	4,00	4,50	4,90

108P 38F

Flessibile in Acciaio Inox AISI 304 - DN6 M10x1 - 3/8°F.
Stainless Steel Flexible hose AISI 304 - DN6 M10x1 - 3/8°F.

cm	20	25	30	35	40	45	50	60	80	100
€	2,40	2,60	2,70	2,80	2,90	3,10	3,20	3,40	3,90	4,40

108LP 38F

Flessibile in Acciaio Inox AISI 304 - DN6 ML10x1 - 3/8°F.
Stainless Steel Flexible hose AISI 304 - DN6 ML10x1 - 3/8°F.

cm	20	25	30	35	40	45	50	60	80	100
€	3,00	3,10	3,30	3,40	3,50	3,60	3,80	4,00	4,50	4,90

FLESSIBILI - FLEXIBLE HOSES

108 8D 12F

Flessibile in Acciaio Inox AISI 304 - DN6 M8x1 - 1/2°F.
Stainless Steel Flexible hose AISI 304 - DN6 M8x1 - 1/2°F.

cm	20	25	30	35	40	45	50	60	80	100
€	2,50	2,60	2,70	2,80	3,00	3,10	3,20	3,40	3,90	4,40



108L 8D 12F

Flessibile in Acciaio Inox AISI 304 - DN6 ML8x1 - 1/2°F.
Stainless Steel Flexible hose AISI 304 - DN6 ML8x1 - 1/2°F.

cm	20	25	30	35	40	45	50	60	80	100
€	2,90	3,10	3,20	3,30	3,40	3,50	3,70	3,90	4,40	4,90



108 8D 38F

Flessibile in Acciaio Inox AISI 304 - DN6 M8x1 - 3/8°F.
Stainless Steel Flexible hose AISI 304 - DN6 ML8x1 - 3/8°F.

cm	20	25	30	35	40	45	50	60	80	100
€	2,50	2,60	2,70	2,80	3,00	3,10	3,20	3,40	3,90	4,40



108L 8D 38F

Flessibile in Acciaio Inox AISI 304 - DN6 ML8x1 - 3/8°F.
Stainless Steel Flexible hose AISI 304 - DN6 ML8x1 - 3/8°F.

cm	20	25	30	35	40	45	50	60	80	100
€	2,90	3,10	3,20	3,30	3,40	3,50	3,70	3,90	4,40	4,90



FLESSIBILI DN 6 ALLUMINIO | DN 6 FLEXIBLES ALUMINIUM

109P 12F

Flessibile in Alluminio DN6 M10x1 - 1/2°F.
Aluminium Flexible hose DN6 M10x1 - 1/2°F.

cm	20	25	30	35	40	45	50	60	80	100
€	2,30	2,40	2,50	2,60	2,70	2,80	2,90	3,00	3,30	3,60



109LP 12F

Flessibile in Alluminio DN6 ML10x1 - 1/2°F.
Aluminium Flexible hose DN6 ML10x1 - 1/2°F.

cm	20	25	30	35	40	45	50	60	80	100
€	2,80	2,90	3,00	3,10	3,20	3,30	3,40	3,50	3,80	4,10



109P 38F

Flessibile in Alluminio DN6 M10x1 - 3/8°F.
Aluminium Flexible hose DN6 M10x1 - 3/8°F.

cm	20	25	30	35	40	45	50	60	80	100
€	2,30	2,40	2,50	2,60	2,70	2,80	2,90	3,00	3,30	3,60



109LP 38F

Flessibile in Alluminio DN6 ML10x1 - 3/8°F.
Aluminium Flexible hose DN6 ML10x1 - 3/8°F.

cm	20	25	30	35	40	45	50	60	80	100
€	2,80	2,90	3,00	3,10	3,20	3,30	3,40	3,50	3,80	4,10



109 8D 12F

Flessibile in Alluminio DN6 M8x1 - 1/2°F.
Aluminium Flexible hose DN6 M8x1 - 1/2°F.

cm	20	25	30	35	40	45	50	60	80	100
€	2,30	2,40	2,50	2,60	2,70	2,80	2,90	3,00	3,30	3,60



109L 8D 12F

Flessibile in Alluminio DN6 ML8x1 - 1/2°F.
Aluminium Flexible hose DN6 ML8x1 - 1/2°F.

cm	20	25	30	35	40	45	50	60	80	100
€	2,80	2,90	3,00	3,10	3,20	3,30	3,40	3,50	3,80	4,10



109 8D 38F

Flessibile in Alluminio DN6 M8x1 - 3/8°F.
Aluminium Flexible hose DN6 M8x1 - 3/8°F.

cm	20	25	30	35	40	45	50	60	80	100
€	2,30	2,40	2,50	2,60	2,70	2,80	2,90	3,00	3,30	3,60



109L 8D 38F

Flessibile in Alluminio DN6 ML8x1 - 3/8°F.
Aluminium Flexible hose DN6 ML8x1 - 3/8°F.

cm	20	25	30	35	40	45	50	60	80	100
€	2,80	2,90	3,00	3,10	3,20	3,30	3,40	3,50	3,80	4,10



DN6

DN8

DN10

DN13

ANTIVIBRANTI
ANTI-VIBRATIONS

TUBI DI RAME E ACCESSORI
COPPER TUBES & ACCESSORIES

FLESSIBILI DN 8 ACCIAIO INOX

FLESSIBILI PER RUBINETTERIA E SANITARI

DN 8 FLEXIBLES STAINLESS STEEL

FLEXIBLES FOR FAUCETS AND SANITARIES



DATI TECNICI - TECHNICAL DATA:

Tubo flessibile trecciato made in Italy in acciaio Inox AISI 304 con interno in gomma alimentare EPDM utilizzato per il collegamento tra la rete idrica e la rubinetteria sanitaria o cassette W.C. e adatto a qualsiasi altro impiego sanitario. Tutti i flessibili sono raccordati con macchine automatiche ed il risultato è l'assoluta precisione di ogni pezzo prodotto per una garanzia di totale qualità.

Made in Italy braided hose in AISI 304 stainless steel with internal in EPDM rubber, used for the connection between the water mains and the sanitary fittings or W.C. flushing tanks. All the hoses are produced with automatic machines and the result is the absolute precision of each produced piece for a total quality guarantee.

APPLICAZIONI APPLICATIONS:



MATERIALI - MATERIALS:

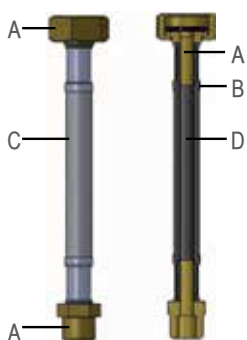

RACCORDI - FITTINGS:

A) Ottone CW614N e CW617N nichelato
Brass CW614N and CW617N nickel plated

BUSSOLE - SLEEVES:

B) Acciaio INOX AISI 304
Stainless steel AISI 304

TUBO - HOSE:

C) Treccia 7 fili in acciaio INOX AISI 304
7 Wires Braid in steel INOX AISI 304
D) Tubo interno: gomma EPDM atossico
Internal pipe EPDM rubber, atoxic

CRATTERISTICHE - FEATURES:



TEMPERATURA INSTALLAZIONE - INSTALLATION TEMPERATURE:

Da -5°C a +90°C - From -5°C to +90°C



PRESSIONE D'ESERCIZIO - WORKING PRESSURE:

10 BAR



PORTATA A 3 BAR - FLOW RATE AT 3 BAR:

29 lit/min



TEMPERATURA D'IMPIEGO - WORKING TEMPERATURE:

-5°C - +90°C



FORO MINIMO PASSAGGIO D'ACQUA - FITTING INNER DIAMETER:

6 mm



RAGGIO CURVATURA MINIMO - MINIMUM BENDING RADIUS:

30 mm



Ø INTERNO - INNER Ø:

Ø 8 mm



Ø ESTERNO - OUTER Ø:

Ø 12 mm

108 12F

Flessibile in Acciaio Inox AISI 304 - DN8 M10x1 - 1/2".
Stainless Steel Flexible hose AISI 304 - DN8 M10x1 - 1/2".

cm	20	25	30	35	40	45	50	60	80	100
€	2,60	2,80	2,90	3,00	3,20	3,30	3,40	3,70	4,30	4,80

108L 12F

Flessibile in Acciaio Inox AISI 304 - DN8 ML10x1 - 1/2".
Stainless Steel Flexible hose AISI 304 - DN8 ML10x1 - 1/2".

cm	20	25	30	35	40	45	50	60	80	100
€	3,00	3,10	3,20	3,40	3,50	3,60	3,80	4,10	4,60	5,10

108 38F

Flessibile in Acciaio Inox AISI 304 - DN8 M10x1 - 3/8".
Stainless Steel Flexible hose AISI 304 - DN8 M10x1 - 3/8".

cm	20	25	30	35	40	45	50	60	80	100
€	2,60	2,80	2,90	3,00	3,20	3,30	3,40	3,70	4,30	4,80

108L 38F

Flessibile in Acciaio Inox AISI 304 - DN8 ML10x1 - 3/8".
Stainless Steel Flexible hose AISI 304 - DN8 ML10x1 - 3/8".

cm	20	25	30	35	40	45	50	60	80	100
€	3,00	3,10	3,20	3,40	3,50	3,60	3,80	4,10	4,60	5,10

FLESSIBILI - FLEXIBLE HOSES

108XL 12F

Flessibile in Acciaio Inox AISI 304 -DN8 MXL10x1 - 1/2°F.
Stainless Steel Flexible hose AISI 304 - DN8 MXL10x1 - 1/2°F.

cm	20	25	30	35	40	45	50	60	80	100
€	3,70	3,80	4,00	4,10	4,30	4,40	4,60	4,80	5,40	6,00



108XL 38F

Flessibile in Acciaio Inox AISI 304 - DN8 MXL10x1 - 3/8°F.
Stainless Steel Flexible hose AISI 304 - DN8 MXL10x1 - 3/8°F.

cm	20	25	30	35	40	45	50	60	80	100
€	3,70	3,80	4,00	4,10	4,30	4,40	4,60	4,80	5,40	6,00

108 12D 12F

Flessibile in Acciaio Inox AISI 304 - DN8 M12x1 - 1/2°F.
Stainless Steel Flexible hose AISI 304 - DN8 M12x1 - 1/2°F.

cm	20	25	30	35	40	45	50	60	80	100
€	2,90	3,00	3,20	3,30	3,40	3,60	3,70	4,00	4,60	5,10



108L 12D 12F

Flessibile in Acciaio Inox AISI 304 - DN8 ML12x1 - 1/2°F.
Stainless Steel Flexible hose AISI 304 - DN8 ML12x1 - 1/2°F.

cm	20	25	30	35	40	45	50	60	80	100
€	3,90	4,10	4,20	4,40	4,50	4,70	4,80	5,10	5,60	6,20



108 12D 38F

Flessibile in Acciaio Inox AISI 304 - DN8 M12x1 - 3/8°F.
Stainless Steel Flexible hose AISI 304 - DN8 M12x1 - 3/8°F.

cm	20	25	30	35	40	45	50	60	80	100
€	2,90	3,00	3,20	3,30	3,40	3,60	3,70	4,00	4,60	5,10



108L 12D 38F

Flessibile in Acciaio Inox AISI 304 - DN8 ML12x1 - 3/8°F.
Stainless Steel Flexible hose AISI 304 - DN8 ML12x1 - 3/8°F.

cm	20	25	30	35	40	45	50	60	80	100
€	3,90	4,10	4,20	4,40	4,50	4,70	4,80	5,10	5,60	6,20



108 TB

Flessibile in Acciaio Inox AISI 304 - DN8 M10x1 - TB10 mm.
Stainless Steel Flexible hose AISI 304 - DN8 M10x1 - TB 10mm.

cm	20	25	30	35	40	45	50	60	80	100
€	2,10	2,20	2,40	2,50	2,70	2,80	3,00	3,30	3,80	4,40



108L TB

Flessibile in Acciaio Inox AISI 304 - DN8 ML10x1 - TB10 mm.
Stainless Steel Flexible hose AISI 304 - DN8 ML10x1 - TB10 mm.

cm	20	25	30	35	40	45	50	60	80	100
€	2,50	2,60	2,80	2,90	3,10	3,20	3,40	3,60	4,20	4,80



108 12F 12F

Flessibile in Acciaio Inox AISI 304 - DN8 1/2°F - 1/2°F.
Stainless Steel Flexible hose AISI 304 - DN8 1/2°F - 1/2°F.

cm	20	25	30	35	40	45	50	60	80	100
€	3,00	3,20	3,30	3,40	3,60	3,70	3,90	4,10	4,70	5,30



108 12M 12F

Flessibile in Acciaio Inox AISI 304 - DN8 1/2°M - 1/2°F.
Stainless Steel Flexible hose AISI 304 - DN8 1/2°M - 1/2°F.

cm	20	25	30	35	40	45	50	60	80	100
€	3,00	3,20	3,30	3,40	3,60	3,70	3,90	4,10	4,70	5,30



108 38F 38F

Flessibile in Acciaio Inox AISI 304 - DN8 3/8°F - 3/8°F.
Stainless Steel Flexible hose AISI 304 - DN8 3/8°F - 3/8°F.

cm	20	25	30	35	40	45	50	60	80	100
€	3,00	3,20	3,30	3,40	3,60	3,70	3,90	4,10	4,70	5,30



108 38M 38F

Flessibile in Acciaio Inox AISI 304 - DN8 3/8°M - 3/8°F.
Stainless Steel Flexible hose AISI 304 - DN8 3/8°M - 3/8°F.

cm	20	25	30	35	40	45	50	60	80	100
€	3,00	3,20	3,30	3,40	3,60	3,70	3,90	4,10	4,70	5,30



108 12F 38F

Flessibile in Acciaio Inox AISI 304 - DN8 1/2°F - 3/8°F.
Stainless Steel Flexible hose AISI 304 - DN8 1/2°F - 3/8°F.

cm	20	25	30	35	40	45	50	60	80	100
€	3,00	3,20	3,30	3,40	3,60	3,70	3,90	4,10	4,70	5,30



108 12M 38F

Flessibile in Acciaio Inox AISI 304 - DN8 1/2°M - 3/8°F.
Stainless Steel Flexible hose AISI 304 - DN8 1/2°M - 3/8°F.

cm	20	25	30	35	40	45	50	60	80	100
€	3,00	3,20	3,30	3,40	3,60	3,70	3,90	4,10	4,70	5,30



DN6

DN8

DN10

DN13

ANTIVIBRANTI
ANTI-VIBRATIONS

TUBI DI RAME E ACCESSORI
COPPER TUBES & ACCESSORIES

108 38M 12F

Flessibile in Acciaio Inox AISI 304 - DN8 3/8" M - 1/2" F.
Stainless Steel Flexible hose AISI 304 - DN8 3/8" M - 1/2" F.

cm	20	25	30	35	40	45	50	60	80	100
€	3,00	3,20	3,30	3,40	3,60	3,70	3,90	4,10	4,70	5,30

108 10B 12F

Flessibile in Acciaio Inox AISI 304 - DN8 10B - 1/2" F.
Stainless Steel Flexible hose AISI 304 - DN8 10B - 1/2" F.

cm	20	25	30	35	40	45	50	60	80	100
€	3,00	3,20	3,30	3,50	3,60	3,80	3,90	4,20	4,80	5,30

108 10B 12M

Flessibile in Acciaio Inox AISI 304 - DN8 10B - 1/2" M.
Stainless Steel Flexible hose AISI 304 - DN8 10B - 1/2" M.

cm	20	25	30	35	40	45	50	60	80	100
€	3,00	3,20	3,30	3,50	3,60	3,80	3,90	4,20	4,80	5,30

108 10B TB

Flessibile in Acciaio Inox AISI 304 - DN8 10B - TB10 mm.
Stainless Steel Flexible hose AISI 304 - DN8 10B - TB10 mm.

cm	20	25	30	35	40	45	50	60	80	100
€	2,40	2,60	2,70	2,90	3,00	3,20	3,30	3,60	4,20	4,80

108 10B 38F

Flessibile in Acciaio Inox AISI 304 - DN8 10B - 3/8" F.
Stainless Steel Flexible hose AISI 304 - DN8 10B - 3/8" F.

cm	20	25	30	35	40	45	50	60	80	100
€	3,00	3,20	3,30	3,50	3,60	3,80	3,90	4,20	4,80	5,30

108 10B 38M

Flessibile in Acciaio Inox AISI 304 - DN8 10B - 3/8" M.
Stainless Steel Flexible hose AISI 304 - DN8 10B - 3/8" M.

cm	20	25	30	35	40	45	50	60	80	100
€	3,00	3,20	3,30	3,50	3,60	3,80	3,90	4,20	4,80	5,30

FLESSIBILI DN 8 ALLUMINIO | ALUMINIUM DN 8 FLEXIBLES

109 12F

Flessibile in Alluminio DN8 M10x1 - 1/2" F.
Aluminium Flexible hose DN8 M10x1 - 1/2" F.

cm	20	25	30	35	40	45	50	60	80	100
€	2,40	2,50	2,60	2,70	2,80	2,90	3,00	3,20	3,60	4,00

109 38F

Flessibile in Alluminio DN8 M10x1 - 3/8" F.
Aluminium Flexible hose DN8 M10x1 - 3/8" F.

cm	20	25	30	35	40	45	50	60	80	100
€	2,40	2,50	2,60	2,70	2,80	2,90	3,00	3,20	3,60	4,00

109XL 12F

Flessibile in Alluminio DN8 MXL10x1 - 1/2" F.
Aluminium Flexible hose DN8 MXL10x1 - 1/2" F.

cm	20	25	30	35	40	45	50	60	80	100
€	3,40	3,50	3,60	3,70	3,80	3,90	4,00	4,20	4,60	4,90

109L 12F

Flessibile in Alluminio DN8 ML10x1 - 1/2" F.
Aluminium Flexible hose DN8 ML10x1 - 1/2" F.

cm	20	25	30	35	40	45	50	60	80	100
€	2,80	2,90	3,00	3,10	3,20	3,30	3,40	3,60	3,90	4,30

109L 38F

Flessibile in Alluminio DN8 ML10x1 - 3/8" F.
Aluminium Flexible hose DN8 ML10x1 - 3/8" F.

cm	20	25	30	35	40	45	50	60	80	100
€	2,80	2,90	3,00	3,10	3,20	3,30	3,40	3,60	3,90	4,30

109XL 38F

Flessibile in Alluminio DN8 MXL10x1 - 3/8" F.
Aluminium Flexible hose DN8 MXL10x1 - 3/8" F.

cm	20	25	30	35	40	45	50	60	80	100
€	3,40	3,50	3,60	3,70	3,80	3,90	4,00	4,20	4,60	4,90

109 12D 12F

Flessibile in Alluminio DN8 M12x1 - 1/2" F.
Aluminium Flexible hose DN8 M12x1 - 1/2" F.

cm	20	25	30	35	40	45	50	60	80	100
€	2,70	2,80	2,90	3,00	3,10	3,20	3,30	3,40	3,80	4,10

109 12D 38F

Flessibile in Alluminio DN8 M12x1 - 3/8" F.
Aluminium Flexible hose DN8 M12x1 - 3/8" F.

cm	20	25	30	35	40	45	50	60	80	100
€	2,70	2,80	2,90	3,00	3,10	3,20	3,30	3,40	3,80	4,10

109L 12D 12F

Flessibile in Alluminio DN8 ML12x1 - 1/2" F.
Aluminium Flexible hose DN8 ML12x1 - 1/2" F.

cm	20	25	30	35	40	45	50	60	80	100
€	3,80	3,90	4,00	4,10	4,20	4,30	4,40	4,60	5,00	5,30

109L 12D 38F

Flessibile in Alluminio DN8 ML12x1 - 3/8" F.
Aluminium Flexible hose DN8 ML12x1 - 3/8" F.

cm	20	25	30	35	40	45	50	60	80	100
€	3,80	3,90	4,00	4,10	4,20	4,30	4,40	4,60	5,00	5,30

FLESSIBILI - FLEXIBLE HOSES

109 TB

Flessibile in Alluminio DN8 M10x1 - TB10 mm.
Aluminium Flexible hose DN8 M10x1 - TB 10mm.

cm	20	25	30	35	40	45	50	60	80	100
€	1,70	1,80	1,90	2,00	2,10	2,20	2,30	2,50	2,80	3,20



109L TB

Flessibile in Alluminio DN8 ML10x1 - TB10 mm.
Aluminium Flexible hose DN8 ML10x1 - TB10 mm.

cm	20	25	30	35	40	45	50	60	80	100
€	2,00	2,10	2,20	2,30	2,40	2,50	2,60	2,80	3,20	3,60



109 12F 12F

Flessibile in Alluminio DN8 1/2"F - 1/2"F.
Aluminium Flexible hose DN8 1/2"F - 1/2"F.

cm	20	25	30	35	40	45	50	60	80	100
€	2,80	2,90	3,00	3,10	3,20	3,30	3,40	3,60	4,00	4,40



109 12M 12F

Flessibile in Alluminio DN8 1/2"M - 1/2"F.
Aluminium Flexible hose DN8 1/2"M - 1/2"F.

cm	20	25	30	35	40	45	50	60	80	100
€	2,80	2,90	3,00	3,10	3,20	3,30	3,40	3,60	4,00	4,40



109 38F 38F

Flessibile in Alluminio DN8 3/8"F - 3/8"F.
Aluminium Flexible hose DN8 3/8"F - 3/8"F.

cm	20	25	30	35	40	45	50	60	80	100
€	2,80	2,90	3,00	3,10	3,20	3,30	3,40	3,60	4,00	4,40



109 38M 38F

Flessibile in Alluminio DN8 3/8"M - 3/8"F.
Aluminium Flexible hose DN8 3/8"M - 3/8"F.

cm	20	25	30	35	40	45	50	60	80	100
€	2,80	2,90	3,00	3,10	3,20	3,30	3,40	3,60	4,00	4,40



109 12F 38F

Flessibile in Alluminio DN8 1/2"F - 3/8"F.
Aluminium Flexible hose DN8 1/2"F - 3/8"F.

cm	20	25	30	35	40	45	50	60	80	100
€	2,80	2,90	3,00	3,10	3,20	3,30	3,40	3,60	4,00	4,40



109 38M 12F

Flessibile in Alluminio DN8 3/8"M - 1/2"F.
Aluminium Flexible hose DN8 3/8"M - 1/2"F.

cm	20	25	30	35	40	45	50	60	80	100
€	2,80	2,90	3,00	3,10	3,20	3,30	3,40	3,60	4,00	4,40



109 12M 38F

Flessibile in Alluminio DN8 1/2"M - 3/8"F.
Aluminium Flexible hose DN8 1/2"M - 3/8"F.

cm	20	25	30	35	40	45	50	60	80	100
€	2,80	2,90	3,00	3,10	3,20	3,30	3,40	3,60	4,00	4,40



109 10B 12F

Flessibile in Alluminio DN8 10B - 1/2"F.
Aluminium Flexible hose DN8 10B - 1/2"F.

cm	20	25	30	35	40	45	50	60	80	100
€	2,70	2,80	2,90	3,00	3,10	3,20	3,30	3,50	3,90	4,30



109 10B 38F

Flessibile in Alluminio DN8 10B - 3/8"F.
Aluminium Flexible hose DN8 10B - 3/8"F.

cm	20	25	30	35	40	45	50	60	80	100
€	2,70	2,80	2,90	3,00	3,10	3,20	3,30	3,50	3,90	4,30



109 10B 12M

Flessibile in Alluminio DN8 10B - 1/2"M.
Aluminium Flexible hose DN8 10B - 1/2"M.

cm	20	25	30	35	40	45	50	60	80	100
€	2,70	2,80	2,90	3,00	3,10	3,20	3,30	3,50	3,90	4,30



109 10B 38M

Flessibile in Alluminio DN8 10B - 3/8"M.
Aluminium Flexible hose DN8 10B - 3/8"M.

cm	20	25	30	35	40	45	50	60	80	100
€	2,70	2,80	2,90	3,00	3,10	3,20	3,30	3,50	3,90	4,30



109 10B TB

Flessibile in Alluminio DN8 10B - TB10mm.
Aluminium Flexible hose DN8 10B - TB10mm.

cm	20	25	30	35	40	45	50	60	80	100
€	2,20	2,30	2,40	2,50	2,60	2,70	2,80	3,00	3,30	4,70



DN8

DN8

DN10

DN13

ANTIVIBRANTI
ANTI-VIBRATIONS

TUBI DI RAME E ACCESSORI
COPPER TUBES & ACCESSORIES

FLESSIBILI DN 10 ACCIAIO INOX

FLESSIBILI PER SANITARI

DN 10 FLEXIBLES STAINLESS STEEL

FLEXIBLES FOR SANITARIES



DATI TECNICI - TECHNICAL DATA:

Tubo flessibile trecciato made in Italy in acciaio Inox AISI 304 con interno in gomma alimentare EPDM utilizzato prevalentemente per il collegamento tra la rete idrica e i rubinetti singoli, gli scaldabagni, le pareti doccia attrezzate e le vasche idromassaggio oltre che ai rubinetti posti sulle cucine industriali. Tutti i flessibili sono raccordati con macchine automatiche ed il risultato è l'assoluta precisione di ogni pezzo prodotto per una garanzia di totale qualità.

Made in Italy braided hose in AISI 304 stainless steel with internal in non-toxic EPDM rubber, mainly used for the connection between the water mains and the single faucet, the boilers, the equipped shower sets and the hydromassage tubs, besides the taps are placed on industrial kitchens. All the hoses are produced with automatic machines and the result is the absolute precision of each produced piece for a total quality guarantee.

APPLICAZIONI APPLICATIONS:



MATERIALI - MATERIALS:

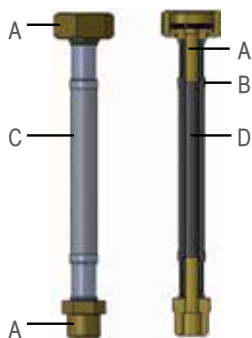

RACCORDI - FITTINGS:

A) Ottone CW614N e CW617N nichelato
Brass CW614N and CW617N nickel plated

BUSSOLE - SLEEVES:

B) Acciaio INOX AISI 304
Stainless steel AISI 304

TUBO - HOSE:

C) Treccia 7-8 fili in acciaio INOX AISI 304
7-8 Wires Braid in steel INOX AISI 304
D) Tubo interno: gomma EPDM atossico
Internal pipe EPDM rubber, atoxic

CRATTERISTICHE - FEATURES:



TEMPERATURA INSTALLAZIONE - INSTALLATION TEMPERATURE:
Da -5°C a +90°C - From -5°C to +90°C



PRESSIONE D'ESERCIZIO - WORKING PRESSURE:
10 BAR



PORTATA A 3 BAR - FLOW RATE AT 3 BAR:
42 lit/min



TEMPERATURA D'IMPIEGO - WORKING TEMPERATURE:
-5°C - +90°C



FORO MINIMO PASSAGGIO D'ACQUA - FITTING INNER DIAMETER:
7 mm



RAGGIO CURVATURA MINIMO - MINIMUM BENDING RADIUS:
30 mm



Ø INTERNO - INNER Ø:
Ø 10 mm



Ø ESTERNO - OUTER Ø:
Ø 14 mm

100 12F 12F

Flessibile in Acciaio Inox AISI 304 - DN10 1/2°F - 1/2°F.
Stainless Steel Flexible hose AISI 304 - DN10 1/2°F - 1/2°F.

cm	20	25	30	35	40	45	50	60	80	100
€	3,00	3,10	3,20	3,30	3,50	3,70	3,80	4,10	4,70	5,30



100 12M 12F

Flessibile in Acciaio Inox AISI 304 - DN10 1/2°M - 1/2°F.
Stainless Steel Flexible hose AISI 304 - DN10 1/2°M - 1/2°F.

cm	20	25	30	35	40	45	50	60	80	100
€	3,00	3,10	3,20	3,30	3,50	3,70	3,80	4,10	4,70	5,30



100 38F 38F

Flessibile in Acciaio Inox AISI 304 - DN10 3/8°F - 3/8°F.
Stainless Steel Flexible hose AISI 304 - DN10 3/8°F - 3/8°F.

cm	20	25	30	35	40	45	50	60	80	100
€	3,00	3,10	3,20	3,30	3,50	3,70	3,80	4,10	4,70	5,30



100 38M 38F

Flessibile in Acciaio Inox AISI 304 - DN10 3/8°M - 3/8°F.
Stainless Steel Flexible hose AISI 304 - DN10 3/8°M - 3/8°F.

cm	20	25	30	35	40	45	50	60	80	100
€	3,00	3,10	3,20	3,30	3,50	3,70	3,80	4,10	4,70	5,30



FLESSIBILI - FLEXIBLE HOSES

100 12F 38F

Flessibile in Acciaio Inox AISI 304 - DN10 1/2°F - 3/8°F.
Stainless Steel Flexible hose AISI 304 - DN10 1/2°F - 3/8°F.

cm	20	25	30	35	40	45	50	60	80	100
€	3,00	3,10	3,20	3,30	3,50	3,70	3,80	4,10	4,70	5,30



100 38M 12F

Flessibile in Acciaio Inox AISI 304 - DN10 3/8"M - 1/2°F.
Stainless Steel Flexible hose AISI 304 - DN10 3/8"M - 1/2°F.

cm	20	25	30	35	40	45	50	60	80	100
€	3,00	3,10	3,20	3,30	3,50	3,70	3,80	4,10	4,70	5,30



100 12M 38F

Flessibile in Acciaio Inox AISI 304 - DN10 1/2"M - 3/8°F.
Stainless Steel Flexible hose AISI 304 - DN10 1/2"M - 3/8°F.

cm	20	25	30	35	40	45	50	60	80	100
€	3,00	3,10	3,20	3,30	3,50	3,70	3,80	4,10	4,70	5,30



100 34M 12F

Flessibile in Acciaio Inox AISI 304 - DN10 3/4"M - 1/2°F.
Stainless Steel Flexible hose AISI 304 - DN10 3/4"M - 1/2°F.

cm	20	25	30	35	40	45	50	60	80	100
€	4,00	4,20	4,30	4,40	4,60	4,80	4,90	5,20	5,80	6,40



100 12F 34F

Flessibile in Acciaio Inox AISI 304 - DN10 1/2°F - 3/4°F.
Stainless Steel Flexible hose AISI 304 - DN10 1/2°F - 3/4°F.

cm	20	25	30	35	40	45	50	60	80	100
€	4,00	4,20	4,30	4,40	4,60	4,80	4,90	5,20	5,80	6,40



100 12M 34F

Flessibile in Acciaio Inox AISI 304 - DN10 1/2"M - 3/4°F.
Stainless Steel Flexible hose AISI 304 - DN10 1/2"M - 3/4°F.

cm	20	25	30	35	40	45	50	60	80	100
€	4,00	4,20	4,30	4,40	4,60	4,80	4,90	5,20	5,80	6,40



100 34F 34F

Flessibile in Acciaio Inox AISI 304 - DN10 3/4°F - 3/4°F.
Stainless Steel Flexible hose AISI 304 - DN10 3/4°F - 3/4°F.

cm	20	25	30	35	40	45	50	60	80	100
€	5,00	5,20	5,30	5,40	5,60	5,80	5,90	6,20	6,80	7,40



100 34M 34F

Flessibile in Acciaio Inox AISI 304 - DN10 3/4"M - 3/4°F.
Stainless Steel Flexible hose AISI 304 - DN10 3/4"M - 3/4°F.

cm	20	25	30	35	40	45	50	60	80	100
€	5,00	5,20	5,30	5,40	5,60	5,80	5,90	6,20	6,80	7,40



100C 12F 12F

Flessibile in Acciaio Inox AISI 304 - DN10 1/2°F - 1/2°F.C.
Stainless Steel Flexible hose AISI 304 - DN10 1/2°F - 1/2°F.C.

cm	20	25	30	35	40	45	50	60	80	100
€	4,60	4,70	4,90	5,00	5,20	5,30	5,50	5,80	6,40	7,00



100C 12M 12F

Flessibile in Acciaio Inox AISI 304 - DN10 1/2"M - 1/2°F.C.
Stainless Steel Flexible hose AISI 304 - DN10 1/2"M - 1/2°F.C.

cm	20	25	30	35	40	45	50	60	80	100
€	4,60	4,70	4,90	5,00	5,20	5,30	5,50	5,80	6,40	7,00



100C 12F 34F

Flessibile in Acciaio Inox AISI 304 - DN10 1/2°F - 3/4°F.C.
Stainless Steel Flexible hose AISI 304 - DN10 1/2°F - 3/4°F.C.

cm	20	25	30	35	40	45	50	60	80	100
€	5,90	6,00	6,20	6,30	6,50	6,70	6,80	7,10	7,80	8,40



100C 12M 34F

Flessibile in Acciaio Inox AISI 304 - DN10 1/2"M - 3/4°F.C.
Stainless Steel Flexible hose AISI 304 - DN10 1/2"M - 3/4°F.C.

cm	20	25	30	35	40	45	50	60	80	100
€	5,90	6,00	6,20	6,30	6,50	6,70	6,80	7,10	7,80	8,40



100C 34F 12F

Flessibile in Acciaio Inox AISI 304 - DN10 3/4°F - 1/2°F.C.
Stainless Steel Flexible hose AISI 304 - DN10 3/4°F - 1/2°F.C.

cm	20	25	30	35	40	45	50	60	80	100
€	5,90	6,00	6,20	6,30	6,50	6,70	6,80	7,10	7,80	8,40



100C 34M 12F

Flessibile in Acciaio Inox AISI 304 - DN10 3/4"M - 1/2°F.C.
Stainless Steel Flexible hose AISI 304 - DN10 3/4"M - 1/2°F.C.

cm	20	25	30	35	40	45	50	60	80	100
€	5,90	6,00	6,20	6,30	6,50	6,70	6,80	7,10	7,80	8,40



DN6

DN8

DN10

DN13

ANTIVIBRANTI
ANTI-VIBRATIONS

TUBI DI RAME E ACCESSORI
COPPER TUBES & ACCESSORIES

100C 38F 12F

Flessibile in Acciaio Inox AISI 304 - DN10 3/8" F - 1/2" FC.
Stainless Steel Flexible hose AISI 304 - DN10 3/8" F - 1/2" FC.

cm	20	25	30	35	40	45	50	60	80	100
€	4,60	4,70	4,90	5,00	5,20	5,30	5,50	5,80	6,40	7,00



100C 38M 12F

Flessibile in Acciaio Inox AISI 304 DN10 - 3/8" M - 1/2" FC.
Stainless Steel Flexible hose AISI 304 DN10 - 3/8" M - 1/2" FC.

cm	20	25	30	35	40	45	50	60	80	100
€	4,60	4,70	4,90	5,00	5,20	5,30	5,50	5,80	6,40	7,00



100C 34F 34F

Flessibile in Acciaio Inox AISI 304 - DN10 3/4" F - 3/4" FC.
Stainless Steel Flexible hose AISI 304 - DN10 3/4" F - 3/4" FC.

cm	20	25	30	35	40	45	50	60	80	100
€	7,00	7,10	7,20	7,40	7,50	7,70	7,90	8,10	8,80	9,40



100C 34M 34F

Flessibile in Acciaio Inox AISI 304 - DN10 3/4" M - 3/4" FC.
Stainless Steel Flexible hose AISI 304 - DN10 3/4" M - 3/4" FC.

cm	20	25	30	35	40	45	50	60	80	100
€	7,00	7,10	7,20	7,40	7,50	7,70	7,90	8,10	8,80	9,40



103 12M 12F

Flessibile in Acciaio Inox AISI 304 - DN10 1/2" ML - 1/2" F.
Stainless Steel Flexible hose AISI 304 - DN10 1/2" ML - 1/2" F.

cm	20	25	30	35	40	45	50	60	80	100
€	3,80	3,90	4,00	4,20	4,30	4,50	4,60	4,90	5,50	6,10



103 38M 38F

Flessibile in Acciaio Inox AISI 304 - DN10 3/8" ML - 3/8" F.
Stainless Steel Flexible hose AISI 304 - DN10 3/8" ML - 3/8" F.

cm	20	25	30	35	40	45	50	60	80	100
€	3,80	3,90	4,00	4,20	4,30	4,50	4,60	4,90	5,50	6,10



103 38M 12F

Flessibile in Acciaio Inox AISI 304 - DN10 3/8" ML - 1/2" F.
Stainless Steel Flexible hose AISI 304 - DN10 3/8" ML - 1/2" F.

cm	20	25	30	35	40	45	50	60	80	100
€	3,80	3,90	4,00	4,20	4,30	4,50	4,60	4,90	5,50	6,10



103 12M 38F

Flessibile in Acciaio Inox AISI 304 - DN10 1/2" ML - 3/8" F.
Stainless Steel Flexible hose AISI 304 - DN10 1/2" ML - 3/8" F.

cm	20	25	30	35	40	45	50	60	80	100
€	3,80	3,90	4,00	4,20	4,30	4,50	4,60	4,90	5,50	6,10



106 12F

Flessibile in Acciaio Inox AISI 304 - DN10 10B - 1/2" F.
Stainless Steel Flexible hose AISI 304 - DN10 10B - 1/2" F.

cm	20	25	30	35	40	45	50	60	80	100
€	3,80	4,00	4,10	4,20	4,40	4,50	4,70	5,00	5,60	6,10



106 12M

Flessibile in Acciaio Inox AISI 304 - DN10 10B - 1/2" M.
Stainless Steel Flexible hose AISI 304 - DN10 10B - 1/2" M.

cm	20	25	30	35	40	45	50	60	80	100
€	3,80	4,00	4,10	4,20	4,40	4,50	4,70	5,00	5,60	6,10



106 38F

Flessibile in Acciaio Inox AISI 304 - DN10 10B - 3/8" F.
Stainless Steel Flexible hose AISI 304 - DN10 10B - 3/8" F.

cm	20	25	30	35	40	45	50	60	80	100
€	3,80	4,00	4,10	4,20	4,40	4,50	4,70	5,00	5,60	6,10



106 38M

Flessibile in Acciaio Inox AISI 304 - DN10 10B - 3/8" M.
Stainless Steel Flexible hose AISI 304 - DN10 10B - 3/8" M.

cm	20	25	30	35	40	45	50	60	80	100
€	3,80	4,00	4,10	4,20	4,40	4,50	4,70	5,00	5,60	6,10



FLESSIBILI DN 10 ALLUMINIO

ALUMINIUM DN 10 FLEXIBLES

101 12F 12F

Flessibile in Alluminio DN10 1/2" F - 1/2" F.
Aluminium Flexible hose DN10 1/2" F - 1/2" F.

cm	20	25	30	35	40	45	50	60	80	100
€	2,70	2,80	2,90	3,00	3,10	3,20	3,30	3,50	3,90	4,20



101 12M 12F

Flessibile in Alluminio DN10 1/2" M - 1/2" F.
Aluminium Flexible hose DN10 1/2" M - 1/2" F.

cm	20	25	30	35	40	45	50	60	80	100
€	2,70	2,80	2,90	3,00	3,10	3,20	3,30	3,50	3,90	4,20



101 38F 38F

Flessibile in Alluminio DN10 3/8" F - 3/8" F.
Aluminium Flexible hose DN10 3/8" F - 3/8" F.

cm	20	25	30	35	40	45	50	60	80	100
€	2,70	2,80	2,90	3,00	3,10	3,20	3,30	3,50	3,90	4,20



101 38M 38F

Flessibile in Alluminio DN10 3/8" M - 3/8" F.
Aluminium Flexible hose DN10 3/8" M - 3/8" F.

cm	20	25	30	35	40	45	50	60	80	100
€	2,70	2,80	2,90	3,00	3,10	3,20	3,30	3,50	3,90	4,20



FLESSIBILI - FLEXIBLE HOSES

101 12F 38F

Flessibile in Alluminio DN10 1/2" F - 3/8" F.
Aluminium Flexible hose DN10 1/2" F - 3/8" F.

cm	20	25	30	35	40	45	50	60	80	100
€	2,70	2,80	2,90	3,00	3,10	3,20	3,30	3,50	3,90	4,20



101 12M 38F

Flessibile in Alluminio DN10 1/2" M - 3/8" F.
Aluminium Flexible hose DN10 1/2" M - 3/8" F.

cm	20	25	30	35	40	45	50	60	80	100
€	2,70	2,80	2,90	3,00	3,10	3,20	3,30	3,50	3,90	4,20



101 38M 12F

Flessibile in Alluminio DN10 3/8" M - 1/2" F.
Aluminium Flexible hose DN10 3/8" M - 1/2" F.

cm	20	25	30	35	40	45	50	60	80	100
€	2,70	2,80	2,90	3,00	3,10	3,20	3,30	3,50	3,90	4,20



101 34M 12F

Flessibile in Alluminio DN10 3/4" M - 1/2" F.
Aluminium Flexible hose DN10 3/4" M - 1/2" F.

cm	20	25	30	35	40	45	50	60	80	100
€	3,80	3,90	4,00	4,10	4,20	4,30	4,40	4,60	5,00	5,30



101 12F 34F

Flessibile in Alluminio DN10 1/2" F - 3/4" F.
Aluminium Flexible hose DN10 1/2" F - 3/4" F.

cm	20	25	30	35	40	45	50	60	80	100
€	3,80	3,90	4,00	4,10	4,20	4,30	4,40	4,60	5,00	5,30



101 12M 34F

Flessibile in Alluminio DN10 1/2" M - 3/4" F.
Aluminium Flexible hose DN10 1/2" M - 3/4" F.

cm	20	25	30	35	40	45	50	60	80	100
€	3,80	3,90	4,00	4,10	4,20	4,30	4,40	4,60	5,00	5,30



101 34F 34F

Flessibile in Alluminio DN10 3/4" F - 3/4" F.
Aluminium Flexible hose DN10 3/4" F - 3/4" F.

cm	20	25	30	35	40	45	50	60	80	100
€	4,80	4,90	5,00	5,10	5,20	5,30	5,40	5,60	6,00	6,30



101 34M 34F

Flessibile in Alluminio DN10 3/4" M - 3/4" F.
Aluminium Flexible hose DN10 3/4" M - 3/4" F.

cm	20	25	30	35	40	45	50	60	80	100
€	4,80	4,90	5,00	5,10	5,20	5,30	5,40	5,60	6,00	6,30



104 12M 12F

Flessibile in Alluminio DN10 1/2" ML - 1/2" F.
Aluminium Flexible hose DN10 1/2" ML - 1/2" F.

cm	20	25	30	35	40	45	50	60	80	100
€	3,60	3,70	3,80	3,90	4,00	4,10	4,20	4,40	4,70	5,10



104 38M 38F

Flessibile in Alluminio DN10 3/8" ML - 3/8" F.
Aluminium Flexible hose DN10 3/8" ML - 3/8" F.

cm	20	25	30	35	40	45	50	60	80	100
€	3,60	3,70	3,80	3,90	4,00	4,10	4,20	4,40	4,70	5,10



104 38M 12F

Flessibile in Alluminio DN10 3/8" ML - 1/2" F.
Aluminium Flexible hose DN10 3/8" ML - 1/2" F.

cm	20	25	30	35	40	45	50	60	80	100
€	3,60	3,70	3,80	3,90	4,00	4,10	4,20	4,40	4,70	5,10



104 12M 38F

Flessibile in Alluminio DN10 1/2" ML - 3/8" F.
Aluminium Flexible hose DN10 1/2" ML - 3/8" F.

cm	20	25	30	35	40	45	50	60	80	100
€	3,60	3,70	3,80	3,90	4,00	4,10	4,20	4,40	4,70	5,10



107 12F

Flessibile in Alluminio DN10 10B - 1/2" F.
Aluminium Flexible hose DN10 10B - 1/2" F.

cm	20	25	30	35	40	45	50	60	80	100
€	3,60	3,70	3,80	3,90	4,00	4,10	4,20	4,40	4,70	5,10



107 12M

Flessibile in Alluminio DN10 10B - 1/2" M.
Aluminium Flexible hose DN10 10B - 1/2" M.

cm	20	25	30	35	40	45	50	60	80	100
€	3,60	3,70	3,80	3,90	4,00	4,10	4,20	4,40	4,70	5,10



107 38F

Flessibile in Alluminio DN10 10B - 3/8" F.
Aluminium Flexible hose DN10 10B - 3/8" F.

cm	20	25	30	35	40	45	50	60	80	100
€	3,60	3,70	3,80	3,90	4,00	4,10	4,20	4,40	4,70	5,10



107 38M

Flessibile in Alluminio DN10 10B - 3/8" M.
Aluminium Flexible hose DN10 10B - 3/8" M.

cm	20	25	30	35	40	45	50	60	80	100
€	3,60	3,70	3,80	3,90	4,00	4,10	4,20	4,40	4,70	5,10



DN6

DN8

DN10

DN13

ANTIVIBRANTI
ANTI-VIBRATIONS

TUBI DI RAME E ACCESSORI
COPPER TUBES & ACCESSORIES

FLESSIBILI DN 10 PVC

FLESSIBILI PER SANITARI

PVC DN 10 FLEXIBLES

FLEXIBLES FOR SANITARIES



DATI TECNICI - TECHNICAL DATA:

Tubo flessibile trecciato made in italy in PVC con interno in gomma alimentare EPDM utilizzato prevalentemente per il collegamento tra la rete idrica e i rubinetti singoli, le pareti doccia attrezzate e le vasche idromassaggio oltre che ai rubinetti posti sulle cucine industriali. Tutti i flessibili sono raccordati con macchine automatiche ed il risultato è l'assoluta precisione di ogni pezzo prodotto per una garanzia di totale qualità.

Made in Italy braided hose in PVC with internal in non-toxic EPDM rubber, mainly used for the connection between the water mains and the single faucet, the equipped shower sets and the hydromassage tubs, besides the taps are placed on industrial kitchens. All the hoses are produced with automatic machines and the result is the absolute precision of each produced piece for a total quality guarantee.

APPLICAZIONI APPLICATIONS:



MATERIALI - MATERIALS:

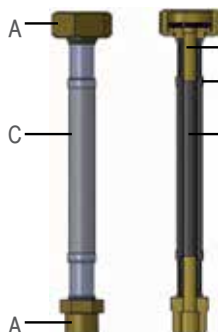

RACCORDI - FITTINGS:

A) Ottone CW614N e CW617N nichelato
Brass CW614N and CW617N nickel plated

BUSSOLE - SLEEVES:

B) Acciaio INOX AISI 304
Stainless steel AISI 304

TUBO - HOSE:

C) Treccia di rinforzo in materiale tessile
Reinforcing braiding in textile material
D) Tubo interno: gomma PVC atossico
Internal pipe PVC rubber, atoxic

CRATTERISTICHE - FEATURES:



TEMPERATURA INSTALLAZIONE - INSTALLATION TEMPERATURE:

Da -5°C a +90°C - From -5°C to +90°C



PRESSIONE D'ESERCIZIO - WORKING PRESSURE:

10 BAR



PORTATA A 3 BAR - FLOW RATE AT 3 BAR:

42 lit/min



TEMPERATURA D'IMPIEGO - WORKING TEMPERATURE:

-5°C - +90°C



FORO MINIMO PASSAGGIO D'ACQUA - FITTING INNER DIAMETER:

7 mm



RAGGIO CURVATURA MINIMO - MINIMUM BENDING RADIUS:

30 mm



Ø INTERNO - INNER Ø:

Ø 10 mm



Ø ESTERNO - OUTER Ø:

Ø 14 mm



99B 12F 12F

Flessibile in PVC DN10 1/2" F - 1/2" F.
PVC Flexible hose DN10 1/2" F - 1/2" F.

cm	20	25	30	35	40	45	50	60	80	100
€	2,80	2,90	3,00	3,10	3,20	3,30	3,40	3,60	3,80	4,10



99B 12M 12F

Flessibile in PVC DN10 1/2" M - 1/2" F.
PVC Flexible hose DN10 1/2" M - 1/2" F.

cm	20	25	30	35	40	45	50	60	80	100
€	2,80	2,90	3,00	3,10	3,20	3,30	3,40	3,60	3,80	4,10

FLESSIBILI - FLEXIBLE HOSES



99B 38F 38F

Flessibile in PVC DN10 3/8" F - 3/8" F.
PVC Flexible hose DN10 3/8" F - 3/8" F.

cm	20	25	30	35	40	45	50	60	80	100
€	2,80	2,90	3,00	3,10	3,20	3,30	3,40	3,60	3,80	4,10



99B 38M 38F

Flessibile in PVC DN10 3/8" M - 3/8" F.
PVC Flexible hose DN10 3/8" M - 3/8" F.

cm	20	25	30	35	40	45	50	60	80	100
€	2,80	2,90	3,00	3,10	3,20	3,30	3,40	3,60	3,80	4,10



99B 12F 38F

Flessibile in PVC DN10 1/2" F - 3/8" F.
PVC Flexible hose DN10 1/2" F - 3/8" F.

cm	20	25	30	35	40	45	50	60	80	100
€	2,80	2,90	3,00	3,10	3,20	3,30	3,40	3,60	3,80	4,10



99B 12M 38F

Flessibile in PVC DN10 1/2" M - 3/8" F.
PVC Flexible hose DN10 1/2" M - 3/8" F.

cm	20	25	30	35	40	45	50	60	80	100
€	2,80	2,90	3,00	3,10	3,20	3,30	3,40	3,60	3,80	4,10



99B 38M 12F

Flessibile in PVC DN10 3/8" M - 1/2" F.
PVC Flexible hose DN10 3/8" M - 1/2" F.

cm	20	25	30	35	40	45	50	60	80	100
€	2,80	2,90	3,00	3,10	3,20	3,30	3,40	3,60	3,80	4,10



99B 12F 34F

Flessibile in PVC DN10 1/2" F - 3/4" F.
PVC Flexible hose DN10 1/2" F - 3/4" F.

cm	20	25	30	35	40	45	50	60	80	100
€	3,80	3,90	4,00	4,10	4,20	4,30	4,40	4,60	4,80	5,10

DN6

DN8

DN10

DN13

ANTIVIBRANTI
ANTI-VIBRATIONS

TUBI DI RAME E ACCESSORI
COPPER TUBES & ACCESSORIES

FLESSIBILI DN 13 ACCIAIO INOX

FLESSIBILI PER SCALDABAGNO,
CALDAIE ED ELETTRODOMESTICI

DN 13 FLEXIBLES STAINLESS STEEL

FLEXIBLES HOSES FOR WATER HEATERS,
BOILERS AND HOUSEHOLD APPLIANCES



DATI TECNICI - TECHNICAL DATA:

Tubo flessibile trecciato made in Italy in acciaio Inox AISI 304 con interno in gomma alimentare EPDM utilizzato prevalentemente per il collegamento tra la rete idrica e i rubinetti singoli, gli scaldabagni, le pareti doccia attrezzate e le vasche idromassaggio oltre che ai rubinetti posti sulle cucine industriali. Tutti i flessibili sono raccordati con macchine automatiche ed il risultato e' l'assoluta precisione di ogni pezzo prodotto per una garanzia di totale qualità.

Made in Italy braided hose in AISI 304 stainless steel with internal in non-toxic EPDM rubber, mainly used for the connection between the water mains and the single faucet, the boilers, the equipped shower sets and the hydromassage tubs, besides the taps are placed on industrial kitchens. All the hoses are produced with automatic machines and the result is the absolute precision of each produced piece for a total quality guarantee.

APPLICAZIONI APPLICATIONS:



MATERIALI - MATERIALS:

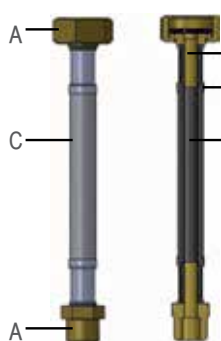

RACCORDI - FITTINGS:

A) CW617N nichelato o giallo
Brass CW617N nickel plated or yellow

BUSSOLE - SLEEVES:

B) Acciaio INOX AISI 304
Stainless steel AISI 304

TUBO - HOSE:

C) Treccia 9 fili in acciaio INOX AISI 304
9 Wires Braid in steel INOX AISI 304
D) Tubo interno: gomma EPDM atossico
Internal pipe EPDM rubber, atoxic

CRATTERISTICHE - FEATURES:



TEMPERATURA INSTALLAZIONE - INSTALLATION TEMPERATURE:

Da -5°C a +90°C - From -5°C to +90°C



PRESSIONE D'ESERCIZIO - WORKING PRESSURE:

16 BAR



PORTATA A 3 BAR - FLOW RATE AT 3 BAR:

65 lit/min



TEMPERATURA D'IMPIEGO - WORKING TEMPERATURE:

-5°C - +90°C



FORO MINIMO PASSAGGIO D'ACQUA - FITTING INNER DIAMETER:

9,3 mm



RAGGIO CURVATURA MINIMO - MINIMUM BENDING RADIUS:

45 mm



Ø INTERNO - INNER Ø:

Ø 13 mm



Ø ESTERNO - OUTER Ø:

Ø 18 mm

116 12F 12F

Flessibile in Acciaio Inox AISI 304 - DN13 1/2"F - 1/2"F
Stainless Steel Flexible hose AISI 304 - DN13 1/2"F - 1/2"F

cm	20	25	30	35	40	45	50	60	80	100
€	3,90	4,10	4,30	4,60	4,80	5,00	5,20	5,60	6,50	7,30

116 12M 12F

Flessibile in Acciaio Inox AISI 304 - DN13 1/2"M - 1/2"F
Stainless Steel Flexible hose AISI 304 - DN13 1/2"M - 1/2"F

cm	20	25	30	35	40	45	50	60	80	100
€	3,90	4,10	4,30	4,60	4,80	5,00	5,20	5,60	6,50	7,30

116 34F 34F

Flessibile in Acciaio Inox AISI 304 - DN13 3/4"F - 3/4"F
Stainless Steel Flexible hose AISI 304 - DN13 3/4"F - 3/4"F

cm	20	25	30	35	40	45	50	60	80	100
€	6,00	6,20	6,40	6,60	6,80	7,00	7,20	7,70	8,50	9,40

116 34M 34F

Flessibile in Acciaio Inox AISI 304 - DN13 3/4"M - 3/4"F
Stainless Steel Flexible hose AISI 304 - DN13 3/4"M - 3/4"F

cm	20	25	30	35	40	45	50	60	80	100
€	6,00	6,20	6,40	6,60	6,80	7,00	7,20	7,70	8,50	9,40

FLESSIBILI - FLEXIBLE HOSES

116 12F 34F

Flessibile in Acciaio Inox AISI 304 - DN13 1/2°F - 3/4°F
Stainless Steel Flexible hose AISI 304 - DN13 1/2°F - 3/4°F

cm	20	25	30	35	40	45	50	60	80	100
€	5,10	5,30	5,50	5,70	5,90	6,10	6,30	6,80	7,60	8,50



116 12M 34F

Flessibile in Acciaio Inox AISI 304 - DN13 1/2°M - 3/4°F
Stainless Steel Flexible hose AISI 304 - DN13 1/2°M - 3/4°F

cm	20	25	30	35	40	45	50	60	80	100
€	5,10	5,30	5,50	5,70	5,90	6,10	6,30	6,80	7,60	8,50



116 34M 12F

Flessibile in Acciaio Inox AISI 304 - DN13 3/4°M - 1/2°F
Stainless Steel Flexible hose AISI 304 - DN13 3/4°M - 1/2°F

cm	20	25	30	35	40	45	50	60	80	100
€	5,10	5,30	5,50	5,70	5,90	6,10	6,30	6,80	7,60	8,50



116C 12F 12F

Flessibile in Acciaio Inox AISI 304 - DN13 1/2°F - 1/2°FC
Stainless Steel Flexible hose AISI 304 - DN13 1/2°F - 1/2°FC

cm	20	25	30	35	40	45	50	60	80	100
€	6,60	6,80	7,00	7,20	7,40	7,60	7,90	8,30	9,10	10,00



116C 12M 12F

Flessibile in Acciaio Inox AISI 304 - DN13 1/2°M - 1/2°FC
Stainless Steel Flexible hose AISI 304 - DN13 1/2°M - 1/2°FC

cm	20	25	30	35	40	45	50	60	80	100
€	6,60	6,80	7,00	7,20	7,40	7,60	7,90	8,30	9,10	10,00



116C 34F 34F

Flessibile in Acciaio Inox AISI 304 - DN13 3/4°F - 3/4°FC
Stainless Steel Flexible hose AISI 304 - DN13 3/4°F - 3/4°FC

cm	20	25	30	35	40	45	50	60	80	100
€	9,30	9,50	9,70	9,90	10,10	10,30	10,50	11,00	11,80	12,70



116C 34M 34F

Flessibile in Acciaio Inox AISI 304 - DN13 3/4°M - 3/4°FC
Stainless Steel Flexible hose AISI 304 - DN13 3/4°M - 3/4°FC

cm	20	25	30	35	40	45	50	60	80	100
€	9,30	9,50	9,70	9,90	10,10	10,30	10,50	11,00	11,80	12,70



116C 12F 34F

Flessibile in Acciaio Inox AISI 304 - DN13 1/2°F - 3/4°FC
Stainless Steel Flexible hose AISI 304 - DN13 1/2°F - 3/4°FC

cm	20	25	30	35	40	45	50	60	80	100
€	8,40	8,60	8,80	9,00	9,20	9,50	9,70	10,10	10,90	11,80



116C 12M 34F

Flessibile in Acciaio Inox AISI 304 - DN13 1/2°M - 3/4°FC
Stainless Steel Flexible hose AISI 304 - DN13 1/2°M - 3/4°FC

cm	20	25	30	35	40	45	50	60	80	100
€	8,40	8,60	8,80	9,00	9,20	9,50	9,70	10,10	10,90	11,80



116C 34F 12F

Flessibile in Acciaio Inox AISI 304 - DN13 3/4°F - 1/2°FC
Stainless Steel Flexible hose AISI 304 - DN13 3/4°F - 1/2°FC

cm	20	25	30	35	40	45	50	60	80	100
€	8,40	8,60	8,80	9,00	9,20	9,50	9,70	10,10	10,90	11,80



DN6

DN8

DN10

DN13

ANTIVIBRANTI
ANTI-VIBRATIONS

TUBI DI RAME E ACCESSORI
COPPER TUBES & ACCESSORIES

FLESSIBILI ANTIVIBRANTI

IN ACCIAIO ZINCATO

ANTI-VIBRATION FLEXIBLES

IN GALVANIZED STEEL



DATI TECNICI - TECHNICAL DATA:

Flessibili antivibranti made in Italy rivestiti con treccia in Acciaio Zincato ed interno in tubo in gomma alimentare EPDM utilizzati per il collegamento tra la rete idrica e pompe, caldaie, autoclavi e depuratori, sono disponibili nelle misure da 1/2" fino a 2". Tutti i flessibili sono raccordati con macchine automatiche ed il risultato è l'assoluta precisione di ogni pezzo prodotto per una garanzia di totale qualità.

Made in Italy anti-vibration flexible hoses, galvanized steel braided, with internal in non-toxic EPDM rubber, used for the connection between the water mains and pumps, boilers, autoclaves and water conditioner; available from 1/2" to 2" size. All the hoses are connected with automatic machines and the result is the absolute precision of each produced piece for a total quality guarantee.

APPLICAZIONI APPLICATIONS:



MATERIALI - MATERIALS:

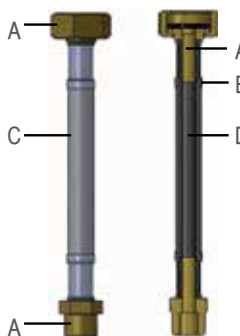

RACCORDI - FITTINGS:

A) Ottone CW614N e CW617N giallo o nichelato
Brass CW614N and CW617N yellow or nickel plated

BUSSOLE - SLEEVES:

B) Alluminio 99,5%
Aluminium 99,5%

TUBO - HOSE:

C) Treccia in Acciaio Zincato
wires braid n stainless steel galvanized
D) Tubo interno: gomma EPDM atossico
Internal pipe EPDM rubber, atoxic

	DN 13 - 1/2"	DN 19 - 3/4"	DN 25 - 1"	DN 32 1" 1/4	DN 40 - 1" 1/2	DN 50 2"
	PRESSIONE D'ESERCIZIO - WORKING PRESSURE:					
	10 BAR	10 BAR	10 BAR	6 BAR	6 BAR	4 BAR
	PORTATA A 3 BAR - FLOW RATE AT 3 BAR:					
	120 lit/min	120 lit/min	200 lit/min	400 lit/min	700 lit/min	1.050 lit/min
	TEMPERATURA D'IMPIEGO - WORKING TEMPERATURE:					
	-10°C +90°C	-10°C +90°C	-10°C +90°C	-10°C +90°C	-10°C +90°C	-10°C +90°C
	FORO MINIMO PASSAGGIO D'ACQUA - FITTING INNER DIAMETER:					
	9,3 mm	15 mm	20 mm	26 mm	32 mm	41 mm
	RAGGIO CURVATURA MINIMO - MINIMUM BENDING RADIUS:					
	45 mm	70 mm	100 mm	190 mm	230 mm	300 mm
	Ø INTERNO - INNER Ø:					
	Ø 13 mm	Ø 19 mm	Ø 25 mm	Ø 30 mm	Ø 40 mm	Ø 50 mm
	Ø ESTERNO - OUTER Ø:					
	Ø 19 mm	Ø 27 mm	Ø 33 mm	Ø 42 mm	Ø 52 mm	Ø 62 mm

FLESSIBILI - FLEXIBLE HOSES

FLESSIBILE IN ACCIAIO ZINCATO E RACCORDI IN OTTONE GIALLO



Flessibile in Acciaio zincato e raccordo in ottone giallo.
Galvanized Steel Flexible hose and yellow brass fittings.

ART.	TUBO - HOSE					RACCORDI - FITTINGS				
	cm	20	30	40	50	60	70	80	90	100
442 12				DN13				1/2" M - 1/2" F		
€	5,50	5,90	6,30	6,70	7,00	7,50	7,80	8,20	8,60	
442 34				DN19				3/4" M - 3/4" F		
€	7,20	7,90	8,70	9,40	10,10	10,90	11,60	12,30	13,10	
442 10				DN25				1" M - 1" F		
€	10,40	11,30	12,20	13,20	14,10	15,00	15,90	16,90	17,80	
442 114				DN32				1 1/4" M - 1 1/4" F		
€	27,20	28,70	30,30	31,80	33,30	34,90	36,40	37,90	39,50	
442 112				DN40				1 1/2" M - 1 1/2" F		
€	40,70	42,80	45,00	47,10	49,20	51,40	53,50	55,70	57,80	
442 20				DN50				2" M - 2" F		
€	55,70	58,40	61,10	63,80	66,60	69,30	72,00	74,70	77,40	

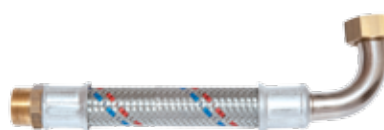

Flessibile in Acciaio zincato e raccordo in ottone giallo.
Galvanized Steel Flexible hose and yellow brass fittings.

ART.	TUBO - HOSE					RACCORDI - FITTINGS				
	cm	20	30	40	50	60	70	80	90	100
442C 12				DN13				1/2" M - 1/2" FC		
€	8,20	8,60	9,00	9,40	9,80	10,20	10,60	11,00	11,50	
442C 34				DN19				3/4" M - 3/4" FC		
€	12,40	13,10	13,90	14,70	15,40	16,20	17,00	17,70	18,50	
442C 10				DN25				1" M - 1" FC		
€	17,10	18,00	19,00	20,00	20,90	21,90	22,90	23,80	24,80	

FLESSIBILE IN ACCIAIO ZINCATO E RACCORDI IN OTTONE NICHELATO



Flessibile in Acciaio zincato e raccordo in ottone nichelato.
Galvanized Steel Flexible hose and nickel plated brass fittings.

ART.	TUBO - HOSE					RACCORDI - FITTINGS				
	cm	20	30	40	50	60	70	80	90	100
441 12				DN13				1/2" M - 1/2" F		
€	5,70	6,10	6,50	6,90	7,30	7,70	8,10	8,50	8,90	
441 34				DN19				3/4" M - 3/4" F		
€	7,30	8,00	8,80	9,50	10,20	11,00	11,70	12,40	13,20	
441 10				DN25				1" M - 1" F		
€	10,50	11,50	12,40	13,30	14,20	15,20	16,10	17,00	18,00	
441 114				DN32				1 1/4" M - 1 1/4" F		
€	27,40	28,90	30,50	32,00	33,50	35,10	36,60	38,20	41,20	
441 112				DN40				1 1/2" M - 1 1/2" F		
€	41,00	43,10	45,20	47,40	49,50	51,70	53,80	55,90	60,20	
441 20				DN50				2" M - 2" F		
€	56,00	58,70	61,40	64,10	66,90	69,60	72,30	75,00	77,70	

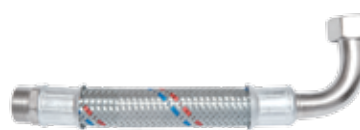

Flessibile in Acciaio zincato e raccordo in ottone nichelato.
Galvanized Steel Flexible hose and nickel plated brass fittings.

ART.	TUBO - HOSE					RACCORDI - FITTINGS				
	cm	20	30	40	50	60	70	80	90	100
441C 12				DN13				1/2" M - 1/2" FC		
€	8,20	8,60	9,00	9,40	9,80	10,20	10,60	11,00	11,50	
441C 34				DN19				3/4" M - 3/4" FC		
€	12,50	13,30	14,00	14,80	15,50	16,30	17,10	17,80	18,60	
441C 10				DN25				1" M - 1" FC		
€	17,30	18,20	19,20	20,10	21,10	22,10	23,00	24,00	25,00	

GALVANIZED STEEL FLEXIBLE HOSE AND YELLOW BRASS FITTINGS



Flessibile in Acciaio zincato e raccordo in ottone giallo.
Galvanized Steel Flexible hose and yellow brass fittings.

ART.	TUBO - HOSE					RACCORDI - FITTINGS				
	cm	20	30	40	50	60	70	80	90	100
442 FF 12				DN13				1/2" F - 1/2" F		
€	5,50	5,90	6,30	6,70	7,00	7,50	7,80	8,20	8,60	
442 FF 34				DN19				3/4" F - 3/4" F		
€	7,20	7,90	8,70	9,40	10,10	10,90	11,60	12,30	13,10	
442 FF 10				DN25				1" F - 1" F		
€	10,40	11,30	12,20	13,20	14,10	15,00	15,90	16,90	17,80	
442 FF 114				DN32				1 1/4" F - 1 1/4" F		
€	27,20	28,70	30,30	31,80	33,30	34,90	36,40	37,90	39,50	
442 FF 112				DN40				1 1/2" F - 1 1/2" F		
€	40,70	42,80	45,00	47,10	49,20	51,40	53,50	55,70	57,80	
442 FF 20				DN50				2" F - 2" F		
€	55,70	58,40	61,10	63,80	66,60	69,30	72,00	74,70	77,40	

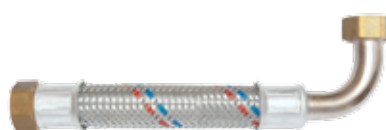

Flessibile in Acciaio zincato e raccordo in ottone giallo.
Galvanized Steel Flexible hose and yellow brass fittings.

ART.	TUBO - HOSE					RACCORDI - FITTINGS				
	cm	20	30	40	50	60	70	80	90	100
442 FC 12				DN13				1/2" F - 1/2" FC		
€	8,20	8,60	9,00	9,40	9,80	10,20	10,60	11,00	11,50	
442 FC 34				DN19				3/4" F - 3/4" FC		
€	12,40	13,10	13,90	14,70	15,40	16,20	17,00	17,70	18,50	
442 FC 10				DN25				1" F - 1" FC		
€	17,10	18,00	19,00	20,00	20,90	21,90	22,90	23,80	24,80	

GALVANIZED STEEL FLEXIBLE HOSE AND NICKEL-PLATED BRASS FITTINGS



Flessibile in Acciaio zincato e raccordo in ottone nichelato.
Galvanized Steel Flexible hose and nickel plated brass fittings.

ART.	TUBO - HOSE					RACCORDI - FITTINGS				
	cm	20	30	40	50	60	70	80	90	100
441 FF 12				DN13				1/2" F - 1/2" F		
€	5,70	6,10	6,50	6,90	7,30	7,70	8,10	8,50	8,90	
441 FF 34				DN19				3/4" F - 3/4" F		
€	7,30	8,00	8,80	9,50	10,20	11,00	11,70	12,40	13,20	
441 FF 10				DN25				1" F - 1" F		
€	10,50	11,50	12,40	13,30	14,20	15,20	16,10	17,00	18,00	
441 FF 114				DN32				1 1/4" F - 1 1/4" F		
€	27,40	28,90	30,50	32,00	33,50	35,10	36,60	38,20	41,20	
441 FF 112				DN40				1 1/2" F - 1 1/2" F		
€	41,00	43,10	45,20	47,40	49,50	51,70	53,80	55,90	60,20	
441 FF 20				DN50				2" F - 2" F		
€	56,00	58,70	61,40	64,10	66,90	69,60	72,30	75,00	77,70	

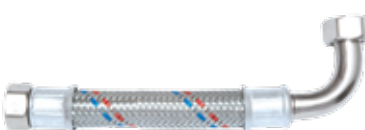

Flessibile in Acciaio zincato e raccordo in ottone nichelato.
Galvanized Steel Flexible hose and nickel plated brass fittings.

ART.	TUBO - HOSE					RACCORDI - FITTINGS				
	cm	20	30	40	50	60	70	80	90	100
441 FC 12				DN13				1/2" F - 1/2" FC		
€	8,20	8,60	9,00	9,40	9,80	10,20	10,60	11,00	11,50	
441 FC 34				DN19				3/4" F - 3/4" FC		
€	12,50	13,30	14,00	14,80	15,50	16,30	17,10	17,80	18,60	
441 FC 10				DN25				1" F - 1" FC		
€	17,30	18,20	19,20	20,10	21,10	22,10	23,00	24,00	25,00	

DN6

DN8

DN10

DN13

ANTIVIBRANTI
ANTI-VIBRATIONS

TUBI DI RAME E ACCESSORI
COPPER TUBES & ACCESSORIES

FLESSIBILI ANTIVIBRANTI INOX

TRECCIA IN ACCIAIO INOX PER POMPE E AUTOCLAVI

STAINLESS STEEL ANTI-VIBRATION FLEXIBLES

STAINLESS STEEL BRAIDED FOR PUMPS AND AUTOCLAVES



DATI TECNICI - TECHNICAL DATA:

Flessibili antivibranti made in Italy rivestiti con treccia in Acciaio Inox AISI 304 ed interno in tubo in gomma alimentare EPDM utilizzati per il collegamento tra la rete idrica e pompe, caldaie, autoclavi e depuratori, sono disponibili nelle misure da 1/2" fino a 2". Tutti i flessibili sono raccordati con macchine automatiche ed il risultato è l'assoluta precisione di ogni pezzo prodotto per una garanzia di totale qualità.

Made in Italy anti-vibration flexible hoses, AISI 304 stainless steel braided, with internal in non-toxic EPDM rubber, used for the connection between the water mains and pumps, boilers, autoclaves and water conditioner; available from 1/2" to 2" size. All the hoses are connected with automatic machines and the result is the absolute precision of each produced piece for a total quality guarantee.

APPLICAZIONI APPLICATIONS:



MATERIALI - MATERIALS:

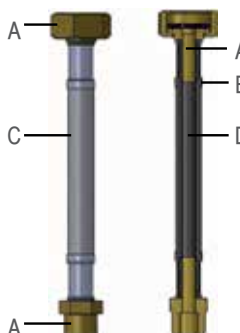

RACCORDI - FITTINGS:

A) Ottone CW614N e CW617N giallo o nichelato
Brass CW614N and CW617N yellow or nickel plated

BUSSOLE - SLEEVES:

B) Alluminio 99,5%
Aluminium 99,5%

TUBO - HOSE:

C) Treccia in Acciaio AISI 304
Braid in Steel AISI 304

D) Tubo interno: gomma EPDM atossico
Internal pipe EPDM rubber, atoxic

	DN 13 - 1/2"	DN 19 - 3/4"	DN 25 - 1"	DN 32 1" 1/4	DN 40 - 1" 1/2	DN 50 2"
PRESSIONE D'ESERCIZIO - WORKING PRESSURE:						
	15 BAR	15 BAR	15 BAR	9 BAR	6 BAR	7 BAR
PORTATA A 3 BAR - FLOW RATE AT 3 BAR:						
	65 lit/min	120 lit/min	200 lit/min	400 lit/min	700 lit/min	1.050 lit/min
TEMPERATURA D'IMPIEGO - WORKING TEMPERATURE:						
	-10°C +90°C	-10°C +90°C	-10°C +90°C	-10°C +90°C	-10°C +90°C	-10°C +90°C
FORO MINIMO PASSAGGIO D'ACQUA - FITTING INNER DIAMETER:						
	9,3 mm	15 mm	20 mm	25 mm	32 mm	40 mm
RAGGIO CURVATURA MINIMO - MINIMUM BENDING RADIUS:						
	45 mm	70 mm	100 mm	190 mm	230 mm	300 mm
Ø INTERNO - INNER Ø:						
	Ø 13 mm	Ø 19 mm	Ø 25 mm	Ø 30 mm	Ø 40 mm	Ø 50 mm
Ø ESTERNO - OUTER Ø:						
	Ø 19 mm	Ø 27 mm	Ø 33 mm	Ø 42 mm	Ø 52 mm	Ø 62 mm

FLESSIBILI - FLEXIBLE HOSES

FLESSIBILE IN ACCIAIO INOX AISI 304 E RACCORDI IN OTTONE NICHELATO



Flessibile in Acciaio INOX AISI 304 e raccordo in ottone nichelato.
Stainless Steel Flexible hose AISI 304 and nickel-plated brass fittings.

ART.	TUBO - HOSE					RACCORDI - FITTINGS				
	cm	20	30	40	50	60	70	80	90	100
443 12					DN13					1/2" M - 1/2" F
€	5,80	6,40	7,00	7,60	8,20	8,80	9,40	10,00	10,60	
443 34					DN19					3/4" M - 3/4" F
€	7,80	8,80	9,80	10,80	11,80	12,80	13,80	14,80	15,80	
443 10					DN25					1" M - 1" F
€	11,10	12,40	13,70	14,90	16,20	17,50	18,80	20,00	21,30	

STAINLESS STEEL FLEXIBLE HOSE AISI 304 AND NICKEL-PLATED BRASS FITTINGS



Flessibile in Acciaio INOX AISI 304 e raccordo in ottone nichelato.
Stainless Steel Flexible hose AISI 304 and nickel-plated brass fittings.

ART.	TUBO - HOSE					RACCORDI - FITTINGS				
	cm	20	30	40	50	60	70	80	90	100
443 FF 12					DN13					1/2" F - 1/2" F
€	5,80	6,40	7,00	7,60	8,20	8,80	9,40	10,00	10,60	
443 FF 34					DN19					3/4" F - 3/4" F
€	7,80	8,80	9,80	10,80	11,80	12,80	13,80	14,80	15,80	
443 FF 10					DN25					1" F - 1" F
€	11,10	12,40	13,70	14,90	16,20	17,50	18,80	20,00	21,30	



Flessibile in Acciaio INOX AISI 304 e raccordo in ottone nichelato.
Stainless Steel Flexible hose AISI 304 and nickel-plated brass fittings.

ART.	TUBO - HOSE					RACCORDI - FITTINGS				
	cm	20	30	40	50	60	70	80	90	100
443C 12					DN13					1/2" M - 1/2" FC
€	8,50	9,10	9,80	10,40	11,00	11,60	12,20	12,80	13,50	
443C 34					DN19					3/4" M - 3/4" FC
€	13,00	14,00	15,00	16,10	17,10	18,20	19,20	20,30	21,30	
443C 10					DN25					1" M - 1" FC
€	17,90	19,20	20,50	21,80	23,10	24,50	25,80	27,10	28,40	



Flessibile in Acciaio INOX AISI 304 e raccordo in ottone nichelato.
Stainless Steel Flexible hose AISI 304 and nickel-plated brass fittings.

ART.	TUBO - HOSE					RACCORDI - FITTINGS				
	cm	20	30	40	50	60	70	80	90	100
443 FC 12					DN13					1/2" F - 1/2" FC
€	8,50	9,10	9,80	10,40	11,00	11,60	12,20	12,80	13,50	
443 FC 34					DN19					3/4" F - 3/4" FC
€	13,00	14,00	15,00	16,10	17,10	18,20	19,20	20,30	21,30	
443 FC 10					DN25					1" F - 1" FC
€	17,90	19,20	20,50	21,80	23,10	24,50	25,80	27,10	28,40	

FLESSIBILE IN ACCIAIO INOX AISI 304 E RACCORDI IN OTTONE GIALLO



Flessibile in Acciaio INOX AISI 304 e raccordo in ottone giallo.
Stainless Steel Flexible hose AISI 304 and yellow brass fittings.

ART.	TUBO - HOSE					RACCORDI - FITTINGS				
	cm	20	30	40	50	60	70	80	90	100
444 12					DN13					1/2" M - 1/2" F
€	5,80	6,40	7,00	7,60	8,20	8,80	9,40	10,00	10,60	
444 34					DN19					3/4" M - 3/4" F
€	7,70	8,70	9,70	10,70	11,70	12,70	13,70	14,70	15,70	
444 10					DN25					1" M - 1" F
€	11,00	12,20	13,50	14,80	16,00	17,30	18,60	19,90	21,10	

STAINLESS STEEL FLEXIBLE HOSE AISI 304 AND YELLOW BRASS FITTINGS



Flessibile in Acciaio INOX AISI 304 e raccordo in ottone giallo.
Stainless Steel Flexible hose AISI 304 and yellow brass fittings.

ART.	TUBO - HOSE					RACCORDI - FITTINGS				
	cm	20	30	40	50	60	70	80	90	100
444 FF 12					DN13					1/2" F - 1/2" F
€	5,80	6,40	7,00	7,60	8,20	8,80	9,40	10,00	10,60	
444 FF 34					DN19					3/4" F - 3/4" F
€	7,70	8,70	9,70	10,70	11,70	12,70	13,70	14,70	15,70	
444 FF 10					DN25					1" F - 1" F
€	11,00	12,20	13,50	14,80	16,00	17,30	18,60	19,90	21,10	



Flessibile in Acciaio INOX AISI 304 e raccordo in ottone giallo.
Stainless Steel Flexible hose AISI 304 and yellow brass fittings.

ART.	TUBO - HOSE					RACCORDI - FITTINGS				
	cm	20	30	40	50	60	70	80	90	100
444C 12					DN13					1/2" M - 1/2" FC
€	8,50	9,20	9,80	10,40	11,00	11,60	12,20	12,90	13,50	
444C 34					DN19					3/4" M - 3/4" FC
€	12,90	13,90	14,90	16,00	17,00	18,10	19,10	20,20	21,20	
444C 10					DN25					1" M - 1" FC
€	17,70	19,00	20,30	21,70	23,00	24,30	25,60	26,90	28,30	



Flessibile in Acciaio INOX AISI 304 e raccordo in ottone giallo.
Stainless Steel Flexible hose AISI 304 and yellow brass fittings.

ART.	TUBO - HOSE					RACCORDI - FITTINGS				
	cm	20	30	40	50	60	70	80	90	100
444 FC 12					DN13					1/2" F - 1/2" FC
€	8,50	9,20	9,80	10,40	11,00	11,60	12,20	12,90	13,50	
444 FC 34					DN19					3/4" F - 3/4" FC
€	12,90	13,90	14,90	16,00	17,00	18,10	19,10	20,20	21,20	
444 FC 10					DN25					1" F - 1" FC
€	17,70	19,00	20,30	21,70	23,00	24,30	25,60	26,90	28,30	

DN6

DN8

DN10

DN13

ANTIVIBRANTI
ANTI-VIBRATIONS

TUBI DI RAME E ACCESSORI
COPPER TUBES & ACCESSORIES

TUBI DI RAME - COPPER TUBES



111 10ROT 5 € 51,40

Tubo in rame ricotto cromato in barre da 5 metri Ø10 mm.
Pipe in soft copper chrome plated in roll of 5 meters, Ø10 mm.



111 12ROT 5 € 62,70

Tubo in rame ricotto cromato in barre da 5 metri Ø12 mm.
Pipe in soft copper chrome plated in roll of 5 meters, Ø12 mm.



111 14ROT 5 € 68,40

Tubo in rame ricotto cromato in barre da 5 metri Ø14 mm.
Pipe in soft copper chrome plated in roll of 5 meters, Ø14 mm.



111 10 100 € 9,30

Tubo in rame ricotto cromato in barre da 1 metro Ø10 mm.
Pipe in soft copper chrome plated in roll of 1 meter, Ø10 mm.



111 10 150 € 13,00

Tubo in rame ricotto cromato in barre da 1,5 metro Ø10 mm.
Pipe in soft copper chrome plated in roll of 1,5 meter, Ø10 mm.



114
Tubo liscio in rame cromato Ø10 mm con cartella e dado.

C.p. copper pipe Ø10 mm with nut.

1/2 L. cm	30	35	40	50
	€ 4,20	€ 4,70	€ 5,50	€ 6,20
3/8 L. cm	30	35	40	50
	€ 4,20	€ 4,70	€ 5,50	€ 6,20



114FF

Tubo liscio in rame cromato Ø10 mm con 2 cartelle e 2 dadi da 1/2.

C.p. copper pipe Ø10 mm with 2 nuts 1/2.

L. cm	30	40	50	60
	€ 5,50	€ 6,40	€ 7,20	€ 8,10



114 M10

Tubo liscio in rame cromato Ø10 mm con attacco filettato 10M x 1.

C.p. copper pipe Ø10 mm threaded 10M x 1.

L. cm	15	35	45	50	60
	€ 2,60	€ 3,30	€ 4,10	€ 5,40	€ 6,10



114 F10

€ 4,90

Tubo liscio in rame cromato Ø10 mm con attacco dado e bicono Ø10 mm. cm 35.

C.p. copper pipe Ø10 mm with nut and 3 pcs washers Ø10 mm. cm 35.

ADATTATORI PER FLESSIBILI - FLEXIBLE HOSES ADAPTER



NEW

Adattatore per flessibili e miscelatori, attacco femmina filetto F10x1, in ottone cromato.
Flexible hoses and mixers adapter, female connection F10x1, in chrome-plated brass.

Art.	Attacco Maschio Male Connection	Attacco Femmina Female Connection	Prezzo
108 RDM 8	M 8 x1	F 10x1	€ 3,30
108 RDM 9	M 9 x1	F 10x1	€ 3,30
108 RDM 11	M 11x1	F 10x1	€ 3,30
108 RDM 12	M 12 x1	F 10x1	€ 3,30

RACCORDI E NIPPLES - CONNECTIONS AND NIPPLES



125 3/8x10 € 2,20 1/2x10 € 2,30
Nipples con guarnizione in gomma, ranella ed anello tagliato in ottone.
1/2 x 10, 3/8x10.
Nipples with nut and 3 pcs washers.
1/2 x 10, 3/8x10.



125 L 1/2x3/8 € 2,90 1/2x10 € 3,60
Nipples prolungato con guarnizione in gomma, ranella ed anello tagliato in ottone. 1/2 x 10.
Extended c.p. nipples with nut and 3 pcs washers. 1/2 x 10.



125 D 3/8x10x10 € 2,70
Doppio nipple con guarnizioni in 3 pezzi. 3/8 x 10 x 10.
C.p. double nipple with nut and 3 pcs washers. 3/8 x 10 x 10.



125 F 3/8x10 € 2,60 1/2x10 € 2,20
Raccordo femmina completo con guarnizioni in 3 pezzi. 1/2 x 10, 3/8x10.
C.p. female connection with nut and 3 pcs washers. 1/2 x 10, 3/8x10.



126 M 1/2x10 € 4,90
Raccordo a gomito con guarnizione in gomma, ranella e anello tagliato in ottone. 1/2 x 10 mm.
Connecting elbow with nut and 3 pcs washers. 1/2 x 10 mm.



126 10x10 € 5,20
Raccordo a gomito con guarnizioni in gomma, ranelle e anelli tagliati in ottone. 10 x 10 mm.
Connecting elbow with 2 nuts and 3 pcs washers. 10 x 10 mm.



126T 10x10x10 € 5,90
Raccordo a T con guarnizioni in gomma, ranelle e anelli tagliati in ottone. 10 x 10 x 10 mm.
Equal T connection with 3 nuts and 3 pcs washers. 10 x 10 x 10 mm.

DN6

DN8

DN10

DN13

ANTIVIBRANTI
ANTI-VIBRATIONS

TUBI DI RAME E ACCESSORI
COPPER TUBES & ACCESSORIES



RR[®]
REMER RUBINETTERIE

MINUTERIA MINUTERY

MINUTERIA
MINUTERY

VALVOLE
VALVES

RACCORDERIA
FITTINGS

ACCESSORI
ACCESSORIES

COMPONENTI PLASTICI
PLASTIC COMPONENTS

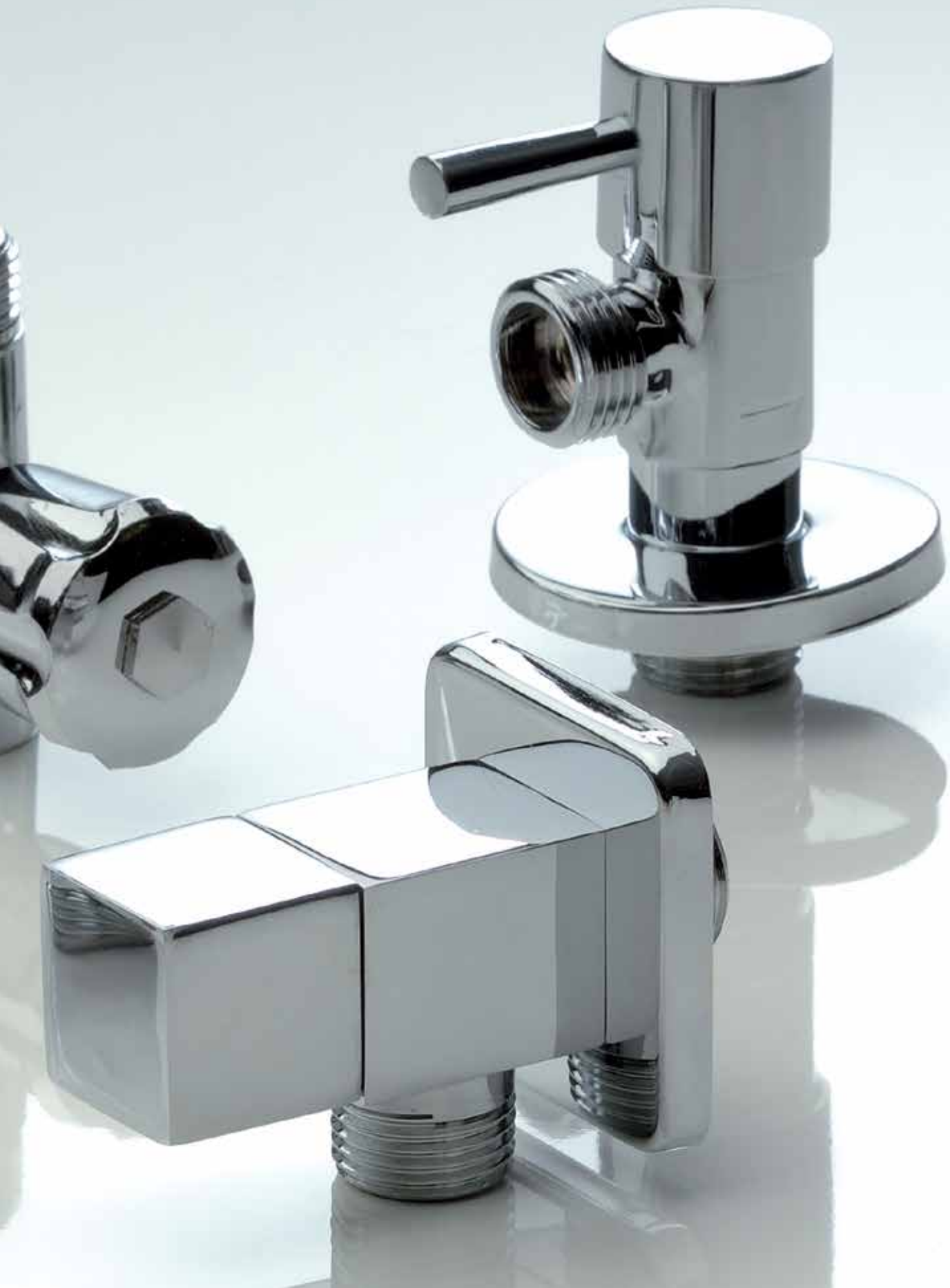

RUBINETTI SOTTOLAVABO - C.P. BRASS ANGLE VALVE



117 RA 3/8x10 € 0,88
Raccordo 3/8x10 con guarnizioni in 3 pezzi.
C.P. nut with 3 pcs washers 3/8x10.



117 RA 12 10 1/2x10 € 3,10
Raccordo 1/2x10 con guarnizioni in 3 pezzi.
C.P. nut with 3 pcs washers 1/2x10.



117 12 38 € 4,80
Rubinetto sottolavabo con rosetta, 1/2x3/8.
C.P. brass angle valve with flange, 1/2x3/8.

117 12 12 € 4,90
Rubinetto sottolavabo con rosetta, 1/2x1/2.
C.P. brass angle valve with flange, 1/2x1/2.



117 12 10 1/2x10 € 5,60
Rubinetto sottolavabo con calotta e rosetta, 1/2x10.
C.P. brass angle valve with flange, 1/2x10.



119 12 1/2Mx1/2M € 74,20
Rubinetto sottolavabo a vitone ceramico, con filtro e valvola di non ritorno, 1/2MX1/2M.
C.p. angle valve with ceramic head valve, with filter and with no return valve, 1/2Mx1/2M.



122 1/2x10 € 7,90
Squadretta sottolavabo con snodo, attacco universale: 1/2, Ø 10 mm, con rosetta in ottone cromato.
C.P. brass angle with ball-joint and flange, 1/2x10.



124 1/2x10 € 6,90
Curvetta sottolavabo, 1/2x10, con rosetta in ottone cromato.
C.P. brass elbow connection for wash basin, with flange, 1/2x10.



124 S 1/2x10 € 8,30
Curvetta sottolavabo stampata, 1/2x10, con rosetta in ottone cromato.
C.P. brass forged elbow connection for wash basin, with flange, 1/2x10.

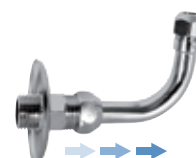

124R 12 10 1/2x10 € 7,10
Curvetta sottolavabo stampata, 1/2x10, allungabile, con rosetta in ottone cromato.
C.P. brass forged elbow connection for wash basin, extendible, with flange, 1/2x10.



120 SN 12 10 1/2x10 € 10,60
Rubinetto sottolavabo a vitone, con filtro e snodo, 1/2x10, con rosetta in ottone cromato.
C.P. brass angle valve with filter, balljoint and c.p. brass flange, 1/2x10.



121 T 1/2x3/4x10 € 14,90
Rubinetto combinato 1/2" sottolavabo e 3/4" attacco lavatrice.
C.P. brass union valve 1/2", with undersink coupling and 3/4" connection for washing machine.



118 Ø 12 € 9,50 Ø 14 € 9,80
Squadretta sottolavabo Ø mm 12 e 14 x cm 15x25, con nipples e dado 1/2.
C.P. brass square angle connection Ø mm 12 and 14 x cm 15x25, with nipples and nut 1/2.



123 12 38 1/2x3/8 € 8,20
Rubinetto sottolavabo con filtro, 1/2x3/8, con rosetta in ottone cromato.
C.P. brass angle valve with filter and flange, 1/2x3/8.



123 12 10 1/2x10 € 9,10
Rubinetto sottolavabo con filtro e calotta, 1/2x10, con rosetta in ottone cromato.
C.P. brass angle valve with filter and flange, 1/2x10.



123 12 12 1/2x1/2 € 8,40
Rubinetto sottolavabo con filtro, 1/2x1/2, con rosetta in ottone cromato.
C.P. brass angle valve with filter and flange, 1/2x1/2.

123 12 34 1/2x3/4 € 8,70
Rubinetto sottolavabo con filtro, 1/2x3/4, con rosetta in ottone cromato.
C.P. brass angle valve with filter and flange, 1/2x3/4.



123 SN 1/2x10 € 10,70
 Rubinetto sottolavabo con filtro e snodo, 1/2x10, con rosetta in ottone cromato.
 C.P. brass angle valve with filter, ball joint and flange, 1/2x10.



127 A 12 38 1/2x3/8 € 5,00
 Rubinetto sottolavabo con filtro, 1/2x3/8, con rosetta in ottone cromato.
 C.P. brass angle valve with filter and flange, 1/2x3/8.



127 A 12 10 1/2x10 € 5,80
 Rubinetto sottolavabo con filtro, calotta, 1/2x10 e rosetta in ottone cromato.
 C.P. brass angle valve with filter and flange, 1/2x10.



127 A 12 12 1/2x1/2 € 5,10
 Rubinetto sottolavabo con filtro, 1/2x1/2, con rosetta in ottone cromato.
 C.P. brass angle valve with filter and flange, 1/2x1/2.



127 A SN 12 10 1/2x10 € 7,40
 Rubinetto sottolavabo con filtro e snodo, 1/2x10, con rosetta in ottone cromato.
 C.P. brass angle valve with filter, ball joint and flange, 1/2x10.



128 R 1/2x1/2 € 5,00 1/2x3/8 € 5,00
 Rubinetto a sfera con guarnizione in PTFE e rosetta, 1/2x1/2, 1/2x3/8.
 C.P. brass ball valve with PTFE washer and flange, 1/2x1/2, 1/2x3/8.



128 R 12 10 1/2x10 € 5,80
 Rubinetto a sfera con guarnizione in PTFE, con calotta e rosetta in ottone cromato, 1/2x10.
 C.P. brass ball valve with PTFE washer and flange, 1/2x10.



121 € 27,80
 Filtro sottolavabo in ottone cromato.
 Chrome plated brass under sink filter.



129 12 12 1/2x1/2 € 6,80
 Rubinetto sottolavabo 1/2x1/2 con rosetta.
 C.P. brass angle valve for wash basin 1/2x1/2 with flange.

129 12 38 1/2x3/8 € 6,30
 Rubinetto sottolavabo 1/2x3/8 con rosetta.
 C.P. brass angle valve for wash basin 1/2x3/8 with flange.

129 12 10 1/2x10 € 7,20
 Rubinetto sottolavabo 1/2x10 con rosetta.
 C.P. brass angle valve for wash basin 1/2x10 with flange.



128L 12 38 1/2x3/8 € 13,00
 Rubinetto sottolavabo "MINIMAL", con vitone ceramico, con maniglia a leva, 1/2x3/8.
 C.P. brass "MINIMAL" angle valve, with ceramic headvalve, with lever handle, 1/2x3/8.



128S 12 38 1/2x3/8 € 19,90
 Rubinetto sottolavabo quadrato, con vitone ceramico, 1/2x3/8.
 C.P. brass squared angle valve, with ceramic head valve, 1/2x3/8.

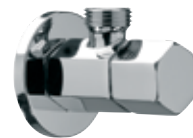

128E 12 38 1/2x3/8 € 17,60
 Rubinetto sottolavabo "Esagonale", con vitone ceramico, 1/2x3/8.
 C.P. brass "Hexagonal" angle valve, with ceramic head valve, 1/2x3/8.

128L 12 10 1/2x10 € 13,80
 Rubinetto sottolavabo "MINIMAL", con vitone ceramico, con maniglia a leva, dado e guarnizione art. 117 RA, 1/2x10.
 C.P. brass "MINIMAL" angle valve, with ceramic headvalve, with lever handle, nut and washers art. 117 RA, 1/2x10.

128S 12 10 1/2x10 € 20,70
 Rubinetto sottolavabo quadrato, con dado e guarnizione art. 117 RA, con vitone ceramico, 1/2x10.
 C.P. brass squared angle valve, with nut and washers art. 117 RA, with ceramic head valve, 1/2x10.

128E 12 10 1/2x10 € 18,40
 Rubinetto sottolavabo "Esagonale", con dado e guarnizione art. 117 RA, con vitone ceramico, 1/2x10.
 C.P. brass "Hexagonal" angle valve, with nut and washers art. 117 RA, with ceramic head valve, 1/2x10.

128L 12 12 1/2x1/2 € 13,30
 Rubinetto sottolavabo "MINIMAL", con vitone ceramico, con maniglia a leva, 1/2x1/2.
 C.P. brass "MINIMAL" angle valve, with ceramic headvalve, with lever handle, 1/2x1/2.

128S 12 12 1/2x1/2 € 20,20
 Rubinetto sottolavabo quadrato, con vitone ceramico, 1/2x1/2.
 C.P. brass squared angle valve, with ceramic head valve, 1/2x1/2.

128E 12 12 1/2x1/2 € 17,90
 Rubinetto sottolavabo "Esagonale", con vitone ceramico, 1/2x1/2.
 C.P. brass "Hexagonal" angle valve, with ceramic head valve, 1/2x1/2.

MINUTERIA
MINUTERY

VALVOLE
VALVES

RACCORDERIA
FITTINGS

ACCESSORI
ACCESSORIES

COMPONENTI PLASTICI
PLASTIC COMPONENTS

ROSETTE - WALL FLANGES



130 OC 1/2 € 0,54

Rosetta pesante in ottone cromato, 1/2.
Heavy wall flange in chrome plated brass 1/2.

130 AC 3/8 € 0,18 1/2 € 0,18

Rosetta pesante in acciaio inox, 3/8, 1/2.
Heavy wall flange in stainless steel, 3/8, 1/2.

130 OC 80 1/2x80 € 3,10

Rosetta pesante in acciaio inox, Ø esterno 80 mm, 1/2.
Heavy wall flange in stainless steel, external Ø 80 mm, 1/2.



132

Rosetta apribile in ottone cromato.
Openable wall flange in c.p. brass.
Ø 10, 12, 14, 3/8, 1/2, 3/4, 1".

10 € 1,10 12 € 1,10 14 € 1,10 3/8 € 1,10

1/2 € 1,10 3/4 € 1,40 1" € 1,60



142

Tappo con rosone e vite, 1/2.
Plug with wall flange and screw, 1/2.

1/2 € 2,10



145

Rosone a muro in ottone cromato, Ø foro mm 26, 30, 32.
Standard wall flange in c.p. brass, Ø hole mm 26, 30, 32.

€ 1,05



130 N

1/2 € 0,91

Rosetta pesante in ottone cromato, per serie minimali, 1/2.
Heavy wall flange in chrome plated brass, for minimal series, 1/2.



131 OC

1/2 € 0,97

Rosetta con alette pesante in ottone cromato Ø mm 57, 1/2.
Heavy wall flange in chrome plated brass Ø 57 mm, 1/2.



136

1/2 € 0,19

Rosetta con foro esagonale in acciaio inox, 1/2.
Stainless steel wall flange with hexagonal hole, 1/2.



130 S

1/2 € 1,70

Rosetta pesante quadrata in ottone cromato, 1/2".
Heavy squared wall flange in c.p. brass, 1/2".



131 AC

1/2 € 0,27 3/4 € 0,31

Rosetta con alette pesante in acciaio INOX Ø mm 57, 1/2 e 2/4.
Heavy wall flange in stainless steel Ø 57 mm, 1/2 and 3/4.



138

€ 8,40

Cappuccio a 2 pezzi universale, per rubinetti incasso, cromato, in ottone.
Universal cap in 2 pieces, for built-in taps, chrome plated, in brass.



144

€ 4,20

Rosone a muro con OR, in ottone cromato, per serie minimali, Ø 32.
Wall flange without OR in c.p. brass, for minimal series, Ø 32.



144 S 32

€ 8,30

Rosone a muro quadrato con OR, in ottone cromato, per serie quadrate e sifoni, Ø 32.
Wall flange with OR, in c.p. brass, for squared series and traps, Ø 32.



146

€ 1,50

Rosone a muro in ottone cromato, Ø est mm.77, Ø foro mm 26, 30, 32, 40.
Wall flange for traps in c.p. brass, ext. Ø 77 mm, hole Ø mm 26, 30, 32, 40.



147

€ 5,50

Rosone a muro gigante in ottone cromato, Ø esterno mm 105, Ø foro mm 26, 30, 32.
Giant wall flange in c.p. brass, external Ø mm 105, hole Ø mm 26, 30, 32.



140 OC

€ 1,50

Rosone Ø mm 77, foro ovale, in ottone cromato.
C.p. brass flange Ø mm 77, with oval hole.



149

€ 2,40

Dado in ottone cromato, 1" con foro Ø mm 26, 1"1/4 Ø 32, 1"1/2 Ø 40.
C.P. round nut, 1" hole Ø 26, 1"1/4 hole Ø 32, 1"1/2 hole Ø 40.

141

€ 6,00

Rosone Ø mm 110, foro ovale, altezza mm 30, in ottone cromato.
C.p. brass flange Ø mm 110, height mm 30, with oval hole.

CANOTTI, RACCORDI E TUBI - TUBES AND CONNECTORS

MINUTERIA
MINUTERY

VALVOLE
VALVES

RACCORDERIA
FITTINGS

ACCESSORI
ACCESSORIES

COMPONENTI PLASTICI
PLASTIC COMPONENTS



150

Canotto in ottone cromato Ø 26, 30, 32, 40 lunghezza cm 30, 100.
C.P. brass tube, plain end, Ø 26, 30, 32, 40 length 30, 100 cm.

Ø26x30 € 5,20 Ø30x30 € 6,00 Ø32x30 € 6,70
Ø32x100 € 19,80 Ø40x30 € 8,40



150 P

Canotto pesante in ottone cromato con spessore 0,6 mm, Ø 32, lunghezza cm 30.
C.P. heavy brass tube, thickness mm 0,6, plain end, Ø 32, length cm 30.

Ø32x30 € 8,00



152

Canotto in ottone cromato con cartella Ø 26, 30, 32 lunghezza cm 30 e Ø 32 lunghezza cm 15, 20, 25.
C.P. brass tube with bordered end Ø 26, 30, 32, length 30 cm and Ø 32 length cm 15, 20, 25.

Ø26x30 € 5,60 Ø32x15 € 4,20 Ø32x25 € 5,70
Ø30x30 € 6,40 Ø32x20 € 4,90 Ø32x30 € 7,10



152 P

Canotto pesante in ottone cromato con spessore 0,6 mm, con cartella, Ø 32, lunghezza cm 30.
C.P. heavy brass tube, thickness mm 0,6, with bordered end, Ø 32, length cm 30.

Ø32x30 € 8,40



153

Canotto telescopico con guarnizione OR, Ø 26, 30, 32 lunghezza cm 13.
Telescopic tube with OR washer, Ø 26, 30, 32 length 13 cm.

Ø26x13 € 5,70 Ø30x13 € 5,90 Ø32x13 € 7,20



154

Raccordo di congiunzione universale, in ottone cromato, Ø 26, 30, 32, 40, con 2 guarnizioni OR.
C.P. brass universal connector, Ø mm 26, 30, 32, 40 with 2 OR washers.

Ø26 € 3,30 Ø30 € 4,00 Ø32 € 4,00 Ø40 € 5,10



154 R

Raccordo di congiunzione universale ridotto, in ottone cromato, Ø 26x32, 32x40, con 2 guarnizioni OR.
C.P. brass universal reduced connector, Ø mm 26x32, 32x40, with 2 OR washers.

Ø26x32 € 4,20 Ø32x40 € 5,10



155

Canotto flessibile in rame cromato, Ø 26, 30, 32, lunghezza cm 30.
Flexible tube in chrome plated copper, Ø 26, 30, 32, length 30 cm.

Ø26x30 € 7,50 Ø30x30 € 9,00 Ø32x30 € 9,70



158

Canotto eccentrico in ottone cromato, Ø 30, lunghezza cm 30.
Eccentric C.P. brass tube, Ø 30, length 30 cm.

Ø30x30 € 9,00



165

Tubo a 90° per scarico cassetta in ottone cromato Ø cm 30, cm 15x25.
90° Tube for water tank for W.C. in C.P. brass Ø 30 cm, 15x25 cm.

€ 8,30



166

Tubo a 45° per scarico cassetta in ottone cromato Ø cm 30.
45° Tube for water tank for W.C. in C.P. brass Ø 30 cm.

€ 6,60



168

Canotto con dado e cartella in ottone cromato con attacco per scarico lavatrice/lavastoviglie, 1"1/4.
C.P. brass pipe with nut and bordered end, plus side connection for washing machine or dishwasher outlet tube, 1"1/4.

1"1/4 € 14,00



170 TU

Tubo a "L" per flussometro esterno, in ottone cromato, Ø 25, 30.
"L" c.p. brass pipe, for wall mounted tap for wc, Ø 25, 30.

Ø 25 € 31,30 Ø 30 € 35,60

PASSO RAPIDO - FLUSHING VALVES



170
Passo rapido esterno, 3/4, 1".
External flushing valve, 3/4, 1".
3/4 € 46,70 1" € 50,90



172 € 32,30
Vitone per passo rapido completo di leva, filetto 19/16, Ø mm 26, 27, 28, 29.
Headvalve for flushing valves, complete with c.p. lever, thread 19/16, Ø mm 26, 27, 28, 29.



172 UNI € 45,10
Vitone universale completo di maniglia per passo rapido, che permette di ottenere 12 combinazioni di misure e lunghezze. Confezione skin-pack.
Universal headvalve for flushing valves, in set with lever, permit to create 12 combinations or lengths and measures. Packed in a safe skinpack.



171 RA
Passo rapido a incasso con ritorno automatico, 3/4, 1".
Built-in flushing valve, with automatic return, 3/4, 1".
3/4 € 80,40 1" € 84,00



171
Passo rapido a incasso con sfiatatoio, 3/4, 1".
Built-in flushing valve, 3/4, 1".
3/4 € 48,40 1" € 53,00

GALLEGGIANTI - FLUSHING VALVES



176 3/8 € 6,70 1/2 € 7,20
Galleggiante "RR" silenzioso, 3/8, 1/2.
"RR" noiseless float valve, 3/8, 1/2.



175
Galleggiante tipo inglese, con tubetto, per forti erogazioni, 1/2, 3/4, 1".
Float valve, english type, with brass pipe, for high pressure, 1/2, 3/4, 1".
1/2 € 11,70 3/4 € 12,60 1" € 16,70



174 AS 3/8 € 9,60
Galleggiante in barra con asta sagomata regolabile, 3/8.
Float valve with adjustable shaped arm, 3/8.



178
Galleggiante con asta in ottone regolabile, 3/4, 1", 1"1/4, 1"1/2, 2".
Float valve with adjustable brass rod, 3/4, 1", 1"1/4, 1"1/2, 2".
3/4 € 14,50 1"1/4 € 54,70 2" € 92,80
1" € 22,10 1"1/2 € 70,90



179 1/2 € 14,30
Galleggiante silenzioso con attacco basso, 1/2.
Float valve noiseless type, bottom inlet, 1/2.



180 € 0,70
Sfera Ø 90 in plastica soffiata con nottolino in ottone.
Plastic ball Ø 90 blown for art. 176 and 179 with brass nut.



182 UNI € 2,50
Sfera Ø 120 in plastica attacco universale: scorrevole, filetto 1/4, filetto 5/16.
Plastic ball Ø 120, universal type (1/4, 5/16, sliding) for art. 175 and 178.



182
Sfera in plastica con scorrevole, Ø 150, 180, 220.
Plastic ball, sliding, Ø 150, 180, 220.
Ø 150 € 3,40 Ø 180 € 4,10
Ø 220 € 8,40



185
Sfera in rame tonda, Ø 85, 120, 150, 180, 220, senza nottolino.
Copper ball for float valves, Ø 85, 120 150, 180, 220, without brass nut.
Ø 85 € 8,60 Ø 150 € 20,80
Ø 120 € 17,50 Ø 180 € 28,30
Ø 220 € 44,20

RUBINETTI - TAPS

MINUTERIA
MINUTERY

VALVOLE
VALVES

RACCORDERIA
FITTINGS

ACCESSORI
ACCESSORIES

COMPONENTI PLASTICI
PLASTIC COMPONENTS



188 1/2 € 9,60
Rubinetto per cassetta cromato, con tubetto e rosone, 1/2".
C.P. tap for W.C. tank with copper pipe and flange, 1/2".

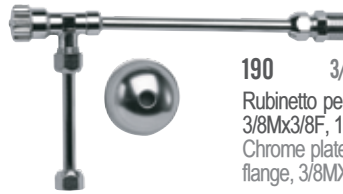

190 3/8MX3/8F € 13,30 1/2MX3/8F € 13,30
Rubinetto per cassetta cromato, con tubetti e rosetta, 3/8MX3/8F, 1/2MX3/8F.
Chrome plated W.C. tank tap, with extension pipes and flange, 3/8MX3/8F, 1/2MX3/8F.



197 1/2 € 7,80
Rubinetto portagomma a sfera, maniglia a leva, pulito e cromato, 1/2".
C.P. brass polished ball bibcock, hose-end with lever handle, 1/2".



198 L 1/2 € 12,60 3/4 € 17,00
Rubinetto portagomma a sfera "LUX", tipo pesante, maniglia a leva, cromato, 1/2, 3/4.
Ball bibcock "LUX", heavy brass type, hose-end with lever handle, 1/2, 3/4.



198
Rubinetto portagomma a sfera, maniglia a leva, cromato, 3/8, 1/2, 3/4, 1".
Brass ball bibcock, hose-end with lever handle in nickel plated brass, 3/8, 1/2, 3/4, 1".
3/8 € 7,20 1/2 € 6,70 3/4 € 9,50 1" € 17,90

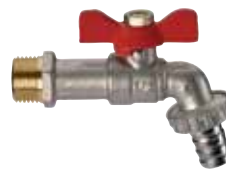

199 1/2 € 6,80
Rubinetto portagomma a sfera, maniglia a farfalla, cromato, 1/2.
Brass ball bibcock, hose-end with T handle in nickel plated brass, 1/2.



200 1/2 € 9,70 3/4 € 13,60
Rubinetto portagomma in ottone giallo, pesante, 1/2, 3/4.
Hose union bibcock in yellow brass, heavy duty, 1/2, 3/4.



200 T 1/2 € 9,20 3/4 € 13,60
Rubinetto portagomma cromato, 1/2, 3/4.
C.p. hose union bibcock, 1/2, 3/4.



201 1/2 € 10,60
Rubinetto curvo in ottone giallo pesante, 1/2.
Plain-end bibcock in yellow brass, heavy duty, 1/2.



202 MA € 29,80
Rubinetto curvo da giardino in ottone giallo trattato, 1/2 a maniglia, con rosetta pesante, aeratore e riduzione 3/4 per portagomma.
Plain-end garden bibcock, heavy duty, in treated yellow brass, 1/2, traditional handle, with heavy flange, aerator and 3/4 reduction for hose connection.



202 LE € 29,40
Rubinetto curvo da giardino in ottone giallo trattato, 1/2 a leva, con rosetta pesante, aeratore e riduzione 3/4 per portagomma.
Plain-end garden bibcock, heavy duty, in treated yellow brass, 1/2, lever type, with heavy flange, aerator and 3/4 reduction for hose connection.



202 MA VI € 4,40
Vitone di ricambio per articolo 202MA.
Spare part headvalve for art 202MA.



204
Lancia per giardinaggio in ottone con portagomma per tubi Ø interno mm 15, misura Ø15x3/4 o mm 19, misura Ø19x3/4.
Gardening nozzle in yellow brass, with hose connection for pipes with internal Ø mm 15, size Ø 15x3/4 or Ø 19, size Ø 19x3/4.
15x3/4 € 6,40 19x3/4 € 6,60



205
Rubinetto a sfera per botte in ottone cromato Ø mm 8, 10, 12, 14, 16, 18, 20.
Ball bibcock in c.p. brass for wine cask, with padlock ring, Ø mm 8, 10, 12, 14, 16, 18, 20.
Ø 8 € 20,50 Ø 16 € 21,30
Ø 10 € 17,80 Ø 18 € 23,90
Ø 12 € 17,80 Ø 20 € 24,70
Ø 14 € 20,40



206
Bocchello per art. 205 (misura del rubinetto) Ø mm 8, 10, 12, 14, 16, 18, 20.
Nozzle end for art. 205, accordingly to size of the tap, Ø mm 8, 10, 12, 14, 16, 18, 20.
Ø 8 € 3,00 Ø 16 € 1,70
Ø 10 € 1,20 Ø 18 € 1,90
Ø 12 € 1,20 Ø 20 € 1,90
Ø 14 € 1,70



209
Raccordo portagomma in ottone giallo, per art. 200, 1/2, 3/4, 1" (misura del rubinetto).
Hose connection for taps in yellow brass, for art. 200, 1/2, 3/4, 1".
1/2 € 1,10 3/4 € 2,10 1" € 3,80



210
Raccordo portagomma in ottone cromato, per art. 198, 1/2, 3/4, 1" (misura del rubinetto).
C.P. hose connection for art. 198, (size of reference tap), 1/2, 3/4, 1".
1/2 € 1,50 3/4 € 2,50 1" € 4,30



209 Y 3/4 € 5,90
Raccordo a Y in ottone giallo, 3/4Fx3/4Mx3/4M.
Y yellow brass connection, 3/4Fx3/4Mx3/4M.



209 Y CR 3/4 € 6,30
Raccordo a Y in ottone cromato, 3/4Fx3/4Mx3/4M.
Y chrome brass connection, 3/4Fx3/4Mx3/4M.



57 EX 1/2 € 20,50
Rubinetto curvo con maniglia mini Y, 1/2.
C.P. polished brass bibcock, with mini Y handle, 1/2.



224 1/2 € 27,80
Rubinetto a snodo con maniglia mini Y, 1/2.
C.P. brass sink tap, with swivel spout, with mini Y handle, 1/2.



250 1/2x3/4 € 28,50
Rubinetto a due maniglie per attacco lavatrice, 1/2x3/4.
C.P. brass washing machine bibcock, heavy model, 1/2x3/4.



250 1/2x3/4 1/2x3/4x3/4 € 28,50
Rubinetto a due maniglie per attacco lavatrice, 1/2x3/4x3/4.
C.P. brass washing machine bibcock, heavy model, 1/2x3/4x3/4.



252 1/2 € 34,50
Rubinetto a snodo con attacco lavatrice, con maniglia mini Y, 1/2.
C.P. brass washing machine bibcock, with swivel spout, with mini Y handle, 1/2.



255 3/4x3/4 € 16,20
Retrogruppo completo di rubinetto a squadra, 3/4x3/4.
C.P. washing machine bibcock, with connection, 3/4x3/4



256 3/4x3/4 € 7,70
Distanziatore per gruppi in ottone cromato, 3/4x3/4, con filtro incorporato.
C.P. brass connection, 3/4x3/4, with incorporated filter.



257 3/4x3/4 € 9,50
Coppia distanzianti con foro 3/8 e senza, in ottone cromato 3/4x3/4.
Set two pieces 3/4 c.p. brass connections with hole and without hole for 3/8 washing machine bibcock.



257 RA 38 3/4x3/4 € 4,90
Distanziatore con foro da 3/8", in ottone cromato.
C.p. brass connections with 3/8" hole.



258 3/4x3/4x3/4 € 15,50
Distanziatore per gruppi, con rubinetto per lavatrice 3/4x3/4x3/4.
C.P. brass washing machine bibcock, with connection, 3/4x3/4x3/4.



258 RA 3/4Mx3/4F € 5,90
Raccordo distanziatore per gruppi, 3/4Mx3/4F.
C.P. brass connection for mixers, 3/4Mx3/4F.



259 1/2x3/4 € 7,60
Rubinetto a tre vie, sottolavabo, per attacco lavatrice, 1/2x3/4.
C.P. three ways washing machine bibcock, brass model, 1/2x3/4.



260 € 5,60
Rubinetto a sfera, a tre vie, sottolavabo, per attacco lavatrice, 1/2Mx1/2Fx3/4M.
C.P. brass three ways washing machine mini ballvalve, 1/2Mx1/2Fx3/4M.



261 1/2x1/2 € 6,80
Rubinetto a sfera, maniglia a farfalla, con rosetta in ottone cromato, 1/2x1/2.
Angle valve with c.p. brass flange, 1/2x1/2.



261
Rubinetto a sfera per lavatrice, maniglia a farfalla, con rosetta in ottone cromato, 1/2x3/4, 3/8x3/4.
C.P. brass hose bibcock for washing machine, with flange in C.P. brass, 1/2x3/4, 3/8x3/4.
1/2x3/4 € 7,20 3/8x3/4 € 7,00



261 NR 1/2x3/4 € 7,70
Rubinetto a sfera, con valvola di non ritorno, con rosetta ottone cromato, 1/2x3/4.
C.P. brass hose bibcock for washing machine, with flange in C.P. brass, 1/2x3/4, with no-return valve.



261 E 1/2x3/4 € 6,10
Rubinetto a sfera per lavatrice, maniglia a leva, con rosetta in ottone cromato, 1/2x3/4.
C.P. brass hose bibcock for washing machine, with flange in C.P. brass, 1/2x3/4.



265
Rubinetto a T normale, 3/8x3/4, 1/2x3/4.
C.P. brass washing machine bibcock, 3/8x3/4, 1/2x3/4.
3/8x3/4 € 6,90 1/2x3/4 € 7,10



280 3/4Mx3/4F € 2,60
Filtro per tubi carico lavatrice, 3/4Mx3/4F.
C.P. filter for washing machine inlet hose, 3/4Mx3/4F.

ACCESSORI PER LAVATRICE - WASHING MACHINE ACCESSORIES



290

Tubo di carico per lavatrice, 3/4F x 3/4F.
Washing machine inlet hose, 3/4F x 3/4F.

cm	100	150	200	250	300
€	2,20	2,65	3,10	3,60	4,00



291

Tubo di carico per lavatrice, con curvetta, 3/4F x 3/4F.
Washing machine inlet hose, with elbow pipe, 3/4F x 3/4F.

cm	100	150	200	250	300	350	400	500
€	2,45	2,90	3,40	3,80	4,20	4,80	5,20	6,10



290 BL

Tubo di carico per lavatrice, colore blu, 3/4F x 3/4F.
Washing machine inlet hose, blue colour, 3/4F x 3/4F.

cm	150	250	350	500
€	2,90	3,90	4,90	6,50



291 BL

Tubo di carico per lavatrice, colore blu, con curvetta, 3/4F x 3/4F.
Washing machine inlet hose, blue colour, with elbow pipe, 3/4F x 3/4F.

cm	150	250	350	500
€	3,10	4,10	5,10	6,70



290 RS

Tubo di carico per lavatrice, colore rosso, 3/4F x 3/4F.
Washing machine inlet hose, red colour, 3/4F x 3/4F.

cm	150	250	350	500
€	2,90	3,90	4,90	6,50



291 RS

Tubo di carico per lavatrice, colore rosso, con curvetta, 3/4F x 3/4F.
Washing machine inlet hose, red colour, with elbow pipe, 3/4F x 3/4F.

cm	150	250	350	500
€	3,10	4,10	5,10	6,70



293

Tubo di carico in treccia acciaio inox gigante, 3/4F x 3/4F.
Washing machine stainless steel inlet hose, 3/4F x 3/4F.

cm	100	150	200	250
€	9,40	11,50	13,60	15,70



294

Tubo di carico in treccia acciaio inox gigante con curvetta, 3/4F x 3/4F.
Washing machine stainless steel inlet hose with elbow pipe, 3/4F x 3/4F.

cm	100	150	200	250
€	11,90	13,90	15,90	17,90



295

Tubo di carico con treccia in nylon bianco con banda grigia, 3/4F x 3/4F.
Washing machine braided in white nylon with grey stripes inlet hose, 3/4F x 3/4F.

cm	100	150	200	250
€	3,90	5,00	6,00	7,10



296

Tubo di carico con treccia in nylon bianco con banda grigia e curvetta, 3/4F x 3/4FC.
Washing machine braided in white nylon with grey stripes inlet hose and elbow pipe, 3/4F x 3/4FC.

cm	100	150	200	250
€	4,10	5,20	6,20	7,30



295 OT

Tubo di carico con treccia in nylon bianco con banda grigia, 3/4F x 3/4F, con dadi in ottone nichelato.
Washing machine braided in white nylon with grey stripes inlet hose, 3/4F x 3/4F, with nickel plated brass nuts.

cm	100	150	200	250
€	7,70	8,80	9,80	10,90



296 OT

Tubo di carico con treccia in nylon bianco con banda grigia e curvetta, 3/4F x 3/4FC, con dadi in ottone nichelato.
Washing machine braided in white nylon with grey stripes inlet hose with elbow pipe, 3/4F x 3/4FC, with nickel plated brass nuts.

cm	100	150	200	250
€	9,40	10,40	11,50	12,50



300 Ø 40 € 3,50
Sifone di scarico per lavatrice, in plastica, con scarico ad innesto o a saldare, Ø mm 40.
Built-in washing machine siphon in black PEHD, outlet to weld or to insert Ø 40 mm.



300 INC Ø 32 - Ø 40 € 4,70
Sifone di scarico per lavatrice, in plastica, con scarico ad incollare, Ø mm 32, 40.
Built-in washing machine siphon in grey PVC, to glue Ø 32, 40 mm.



300 X Ø 40 € 4,80
Sifone di scarico per lavatrice, in plastica, con piastra in acciaio INOX lucidato, con scarico ad innesto o a saldare, Ø mm 40.
Built-in washing machine siphon in black PEHD, with polished stainless steel flange, outlet to weld or to insert Ø 40 mm.



298 3/4Fx3/4Mx3/4M € 1,90
Raccordo a Y in propilene con dado girevole, 3/4Fx3/4Mx3/4M.
Y propylene connection with movable nut 3/4Fx3/4Mx3/4M.



297 3/4 € 0,24
Nipples in nylon, 3/4.
Nipples in nylon, 3/4



299 3/4 € 0,08
Guarnizione in gomma per tubo carico, 3/4.
Rubber washer for inlet hose, 3/4.



307 € 3,40
Portagomma con dado in ottone cromato filetto 1" portagomma Ø mm 18 e mm 22.
Hose-holder with C.P. brass nut thread 1", Ø 18 mm or Ø 22 mm.



308
Giunto in nylon per tubi scarico.
Connection in nylon for waste tubes.

DIMENSIONI - SIZES	Ø 17x17	Ø 17x20	Ø 20x20
€	0,22	0,22	0,22



305 SU € 0,19
Supporto in plastica per art. 305.
Plastic elbow holder for art. 305.



305
Tubo di scarico per lavatrice, in plastica, spiralato.
Washing machine outlet hose, in plastic.

cm	100	150	200	250	300	350	400	500
€	1,20	1,40	1,70	1,90	2,20	2,60	3,00	3,70



306 ES 60 € 2,00
Tubo scarico lavatrice, in plastica estensibile da cm 60 a cm 200.
Extendable corrugate outlet hose for washing machine from cm 60 to cm 200.



305 B
Tubo di scarico per lavatrice in plastica spiralato, con raccordi Ø 22x29.
Washing machine outlet hose, in plastic, with connection Ø 22x29.

cm	100	150	200	250	300	350	400	500
€	1,40	1,60	1,90	2,20	2,40	2,80	3,30	3,90



305 BA
Tubo di scarico per lavatrice, in plastica, spiralato e supporto in plastica, Art 305+305SU in sacchetto.
Washing machine outlet hose, in plastic, with elbow holder, Art 305+305SU, in plastic bag.

cm	150	200	250	300
€	2,10	2,40	2,70	3,00

306 ES 70 € 2,30
Tubo scarico lavatrice, in plastica estensibile da cm 70 a cm 270.
Extendable corrugate outlet hose for washing machine from cm 70 to cm 270.

306 ES 120 € 4,00
Tubo scarico lavatrice, in plastica estensibile da cm 120 a cm 400.
Extendable corrugate outlet hose for washing machine from cm 120 to cm 400.



305 C
Tubo di scarico per lavatrice in plastica spiralato, con raccordo curvo.
Washing machine outlet hose, in plastic, with elbow connection.

cm	100	150	200	250	300	350	400	500
€	1,60	1,80	2,10	2,40	2,70	3,00	3,50	4,20



VALVOLE VALVES



MINUTERIA
MINUTERY

VALVOLE
VALVES

RACCORDERIA
FITTINGS

ACCESSORI
ACCESSORIES

COMPONENTI PLASTICI
PLASTIC COMPONENTS

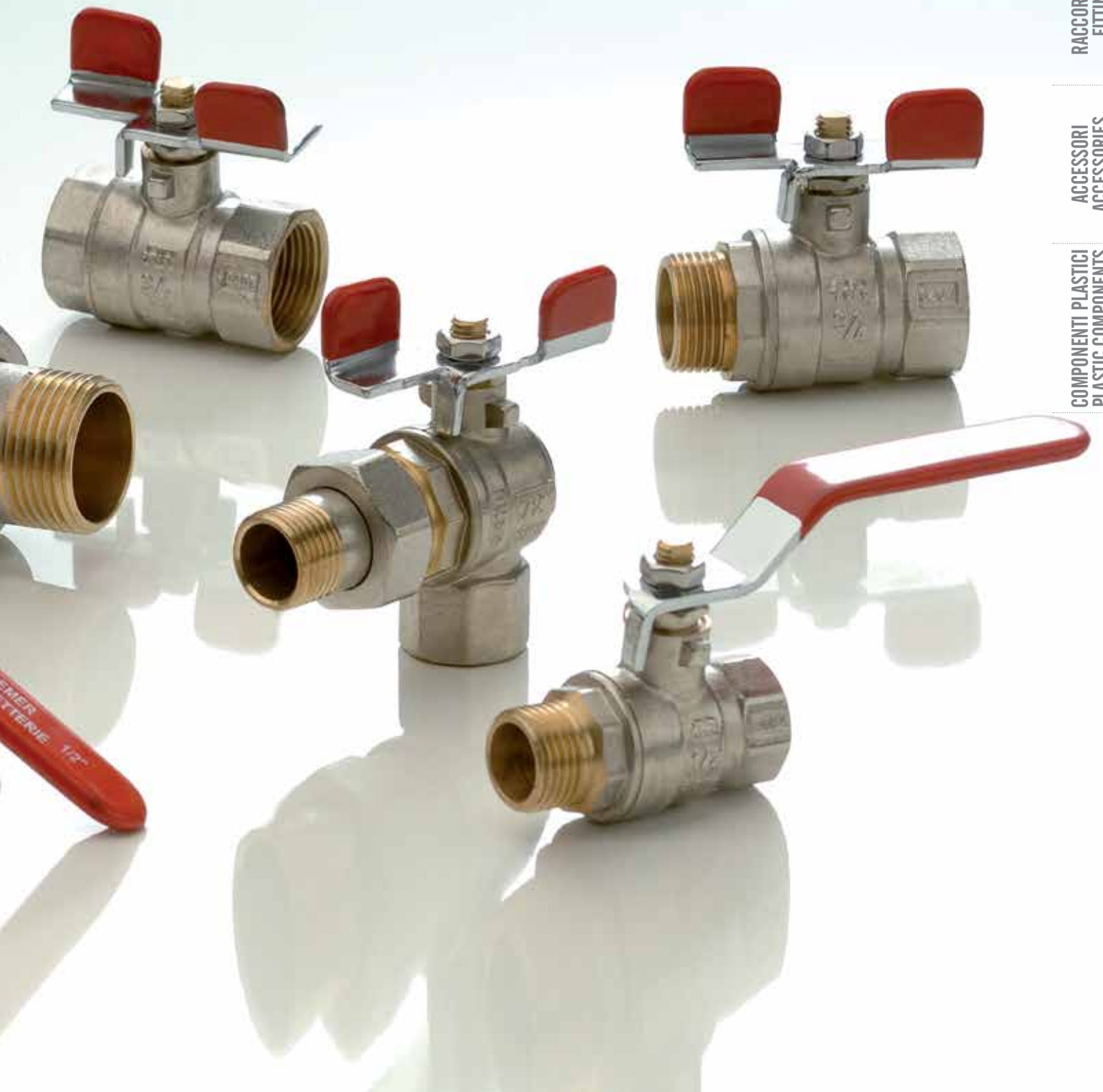

SERIE SEVEN | SEVEN SERIE

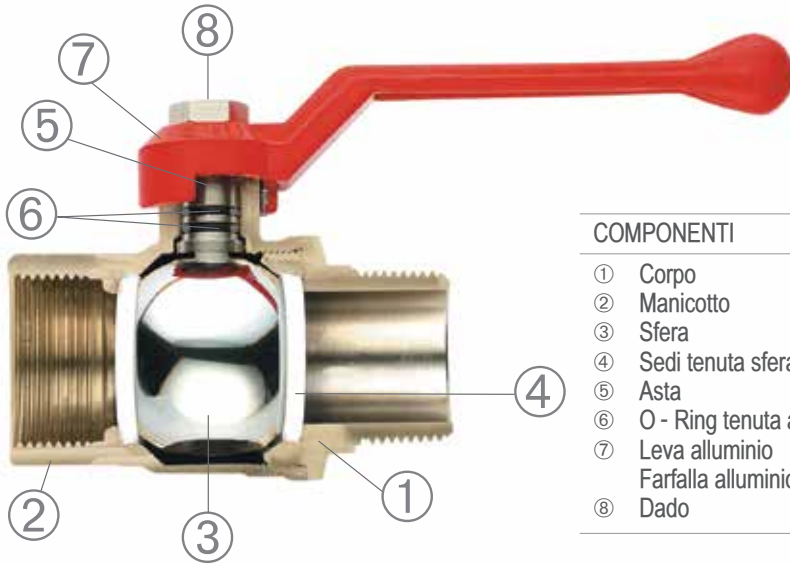

COMPONENTI	COMPONENTS	MATERIALI - MATERIALS
① Corpo	① Body	UNI EN 12165 CW617N
② Manicotto	② End connection	UNI EN 12165 CW617N
③ Sfera	③ Ball	UNI EN 12165 CW617N
④ Sedi tenuta sfera	④ Ball seal	P.T.F.E.
⑤ Asta	⑤ Stem	UNI EN 12164 CW614N
⑥ O - Ring tenuta asta	⑥ Rod seal O - Ring	NBR 70 Sh A (ASTM D 2240)
⑦ Leva alluminio	⑦ Alu handle	AL fire painted
Farfalla alluminio	Butterfly handle	AL fire painted
⑧ Dado	⑧ Nut	Chrome plated Brass

Condizioni d'esercizio: Temperatura: min -15, max +120 - Pressione nominale: max 40 bar.

Working details: Temperature: min -15, max +120 - Nominal pressure: max 40 bar.

- Passaggio: totale
- Gamma: da 1/2" a 2"
- Attacco femmina: filettatura ISO 7/1 Rp (parallela) (DIN 2999)
- Attacco maschio: filettatura ISO 7/1 R (conica) (DIN 2999)
- Codolo e dado: filettatura ISO 228/1 (DIN 259)

- Flow: full
- Range: from 1/2" till 2"
- Female thread: threading ISO 7/1 R (parallel) (DIN 2999)
- Male thread: threading ISO 7/1 R (conical) (DIN 2999)
- Connection fitting and nut: threading ISO 228/1 (DIN 259)

Diagramma perdite di carico/portata
Load losses/flow rate graph

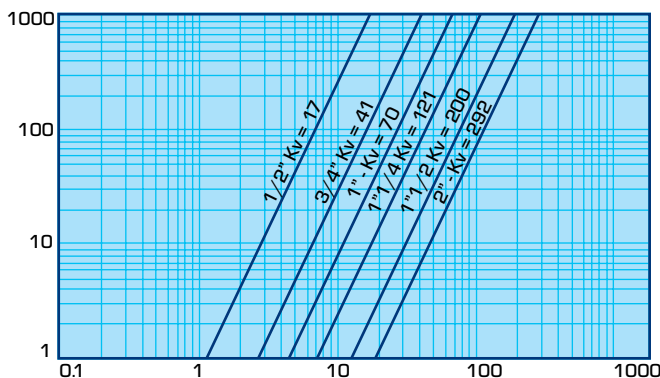

Portata = m³/h di Acqua
Water flow rate = m³/h

Diagramma pressione/temperatura
Pressure/temperature graph

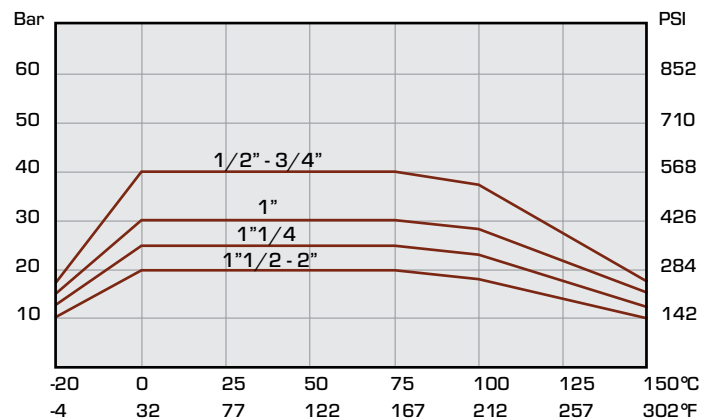

VALVOLE - VALVES

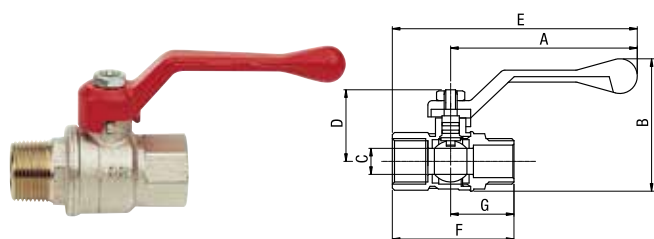

360 MF 1/2" € 6,70 3/4" € 10,20 1" € 14,90
 1 1/4" € 26,40 1 1/2" € 35,00 2" € 54,00

Valvola a sfera M.F. a sette filetti, a passaggio totale, maniglia a leva.
 C.P. full-flow ball valve "seven threads" M.F., with lever handle.

	A	B	C	D	E	F	G
1/2"	84,5	66	15	36,5	115,5	68	38,3
3/4"	110	74	20	43,5	134	76	42,3
1"	110	82,5	25	47	140	87	48
1" 1/4	140	101,5	32	60	188	106	58
1" 1/2	140	112	40	65,5	192,5	114	61,5
2"	170	139,5	50	79	222,5	136,5	73,5

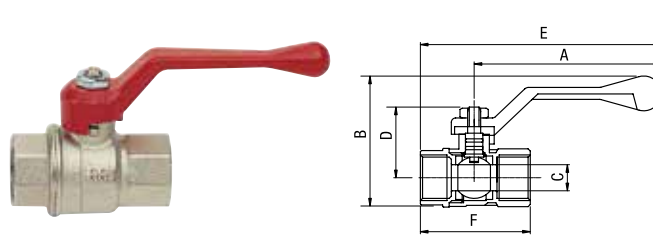

360 FF 1/2" € 6,40 3/4" € 9,50 1" € 14,30
 1 1/4" € 24,40 1 1/2" € 34,10 2" € 53,30

Valvola a sfera F.F. a sette filetti, a passaggio totale, maniglia a leva.
 C.P. full-flow ball valve "seven threads" F.F., with lever handle.

	A	B	C	D	E	F	G
1/2"	84,5	66	15	36,5	115,5	59,5	38,3
3/4"	110	74	20	43,5	134	67,5	42,3
1"	110	82,5	25	47	140	79	48
1" 1/4	140	101,5	32	60	188	96	58
1" 1/2	140	112	40	65,5	192,5	105	61,5
2"	170	139,5	50	79	222,5	126	73,5

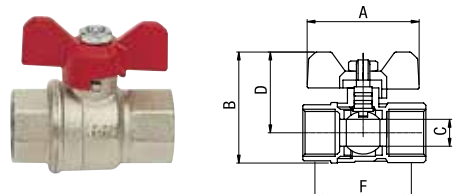

361 FF 1/2" € 6,40 3/4" € 9,50 1" € 14,30

Valvola a sfera F.F. a sette filetti, a passaggio totale, maniglia a farfalla.
 C.P. full-flow ball valve "seven threads" F.F., with T handle.

	A	B	C	D	E	F	G
1/2"	51,5	54,5	15	38,5	59,5	68	38,3
3/4"	63	66,5	20	47	67,5	76	42,3
1"	63	75	25	51	79	87	48

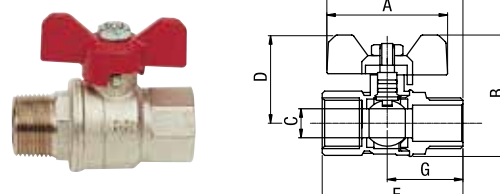

361 MF 1/2" € 6,70 3/4" € 10,20 1" € 14,90

Valvola a sfera F.F. a sette filetti, a passaggio totale, maniglia a farfalla.
 C.P. full-flow ball valve "seven threads" F.F., with T handle.

	A	B	C	D	E	F	G
1/2"	51,5	54,5	15	38,5	64,1	68	38,3
3/4"	63	66,5	20	47	73,8	76	42,3
1"	63	75	25	51	79	87	48

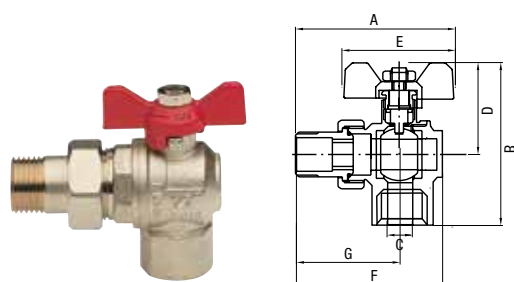

364 C 1/2" € 8,30 3/4" € 13,00 1" € 22,80

Valvola a sfera ad angolo a sette filetti, con bocchettone, passaggio totale, maniglia a farfalla.

C.P. full-flow angle ball valve "seven threads", with union connection, with T handle.

	A	B	C	D	E	F	G
1/2"	87	53	15	37,5	51,5	91	61,5
3/4"	96,5	62,5	20	43,5	62	99	66,5
1"	109,5	70	25	46,5	62	118	78,5

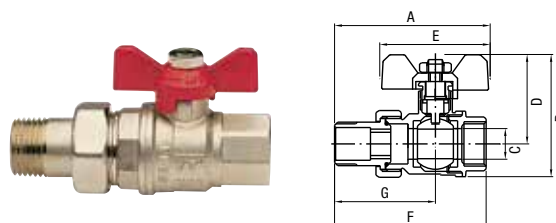

364 1/2" € 7,90 3/4" € 12,60 1" € 21,00

Valvola a sfera a sette filetti, con bocchettone, passaggio totale, maniglia a farfalla.

C.P. full-flow ball valve "seven threads", with union connection, with T handle.

	A	B	C	D	E	F	G
1/2"	84	69,5	13,8	38	51,5	74,5	58,5
3/4"	96,5	81,5	18,5	45	62	85,5	66
1"	111,5	93	23	48	62	103,5	80

MINUTERIA
MINUTERY

VALVOLE
VALVES

RACCORDERIA
FITTINGS

ACCESSORI
ACCESSORIES

COMPONENTI PLASTICI
PLASTIC COMPONENTS

SERIE RR | RR SERIE

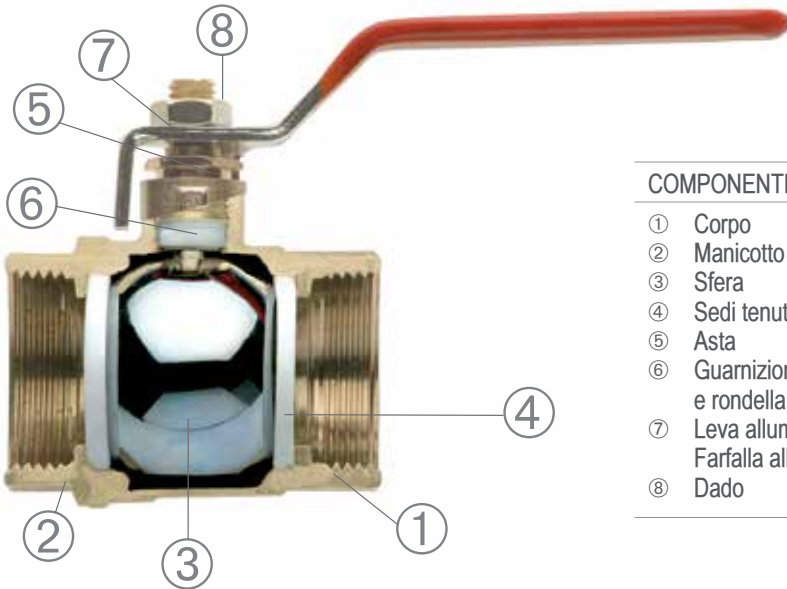

COMPONENTI	COMPONENTS	MATERIALI - MATERIALS
① Corpo	① Body	UNI EN 12165 CW617N
② Manicotto	② End connection	UNI EN 12165 CW617N
③ Sfera	③ Ball	UNI EN 12165 CW617N
④ Sedi tenuta sfera	④ Ball seal	P.T.F.E.
⑤ Asta	⑤ Stem	UNI EN 12164 CW614N
⑥ Guarnizioni tenuta asta e rondella antifrizione	⑥ Stem packing and antifriction ring	P.T.F.E.
⑦ Leva alluminio	⑦ Alu handle	AISI A3 PVC cover
Farfalla alluminio	Butterfly handle	AISI A3 PVC cover
⑧ Dado	⑧ Nut	Chrome plated Brass

Condizioni d'esercizio: Temperatura: min -15, max +120 - Pressione nominale: max 40 bar.

Working details: Temperature: min -15, max +120 - Nominal pressure: max 40 bar.

- Passaggio: totale
- Gamma: da 1/2" a 2"
- Attacco femmina: filettatura ISO 228/1 (DIN 259)
- Attacco maschio: filettatura ISO 228/1 (conica) (DIN 259)
- Codolo e dado: filettatura ISO 228/1 (DIN 259)

- Flow: full
- Range: from 1/2" to 2"
- Female thread: threading ISO 228/1 (DIN 259)
- Male thread: threading ISO 228/1 (DIN 259)
- Connection fitting and nut: threading ISO 228/1 (DIN 259)

Diagramma perdite di carico/portata
Load losses/flow rate graph

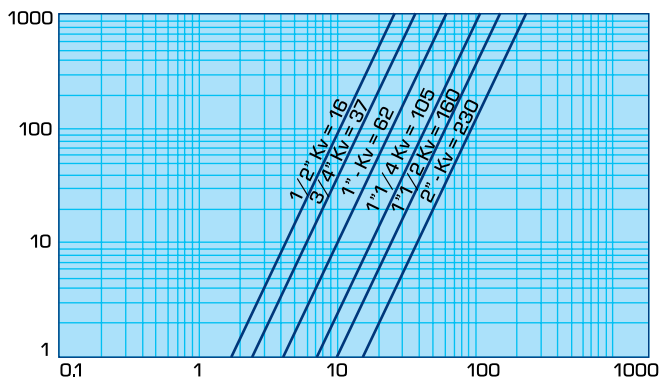

Portata = m³/h di Acqua
Water flow rate = m³/h

Diagramma pressione/temperatura
Pressure/temperature graph

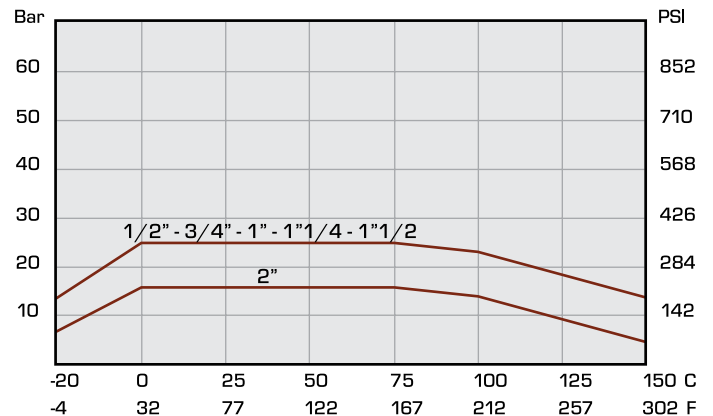

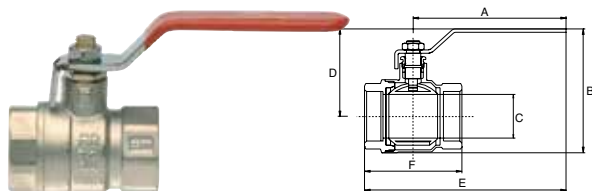

371 RR 1/2 € 5,00 3/4 € 7,00 1" € 11,80 1 1/4 € 18,30
 1 1/2 € 27,60 2" € 38,10 2 1/2 € 87,70 3" € 113,10 4" € 208,80

Valvola a sfera F.F. a passaggio totale, maniglia a leva, linea pesante e ottone visibile.
 C.p. full-flow RR ball valve F.F., heavy line and visible brass with lever handle.

	A	B	C	D	E	F	G
1/2"	95	65	14,5	50	120	48	
3/4"	95	68	18,5	53	124	55	
1"	125	80	23	62	155	63	
1" 1/4	125	97	31,5	69	165	78	
1" 1/2	138	110	31,5	80	180	87	
2"	165	125	50	86	210	100	
2" 1/2	236		62	117	306	140	
3"	225		73	130	330	150	
4"	225		79	142,5	350	190	

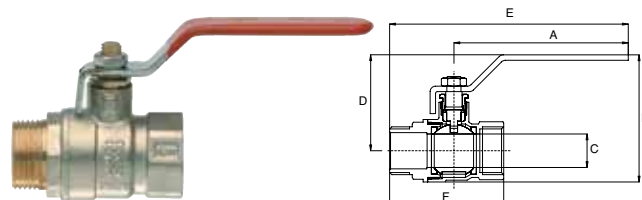

370 RR 1/2 € 5,50 3/4 € 7,40 1" € 12,80
 1 1/4 € 19,70 1 1/2 € 28,50 2" € 41,80

Valvola a sfera M.F. a passaggio totale, maniglia a leva, linea pesante e ottone visibile.
 C.p. full-flow RR ball valve M.F. heavy line and visible brass with lever handle.

	A	B	C	D	E	F	G
1/2"	95	65	14,5	50	120	63	
3/4"	95	68	18,5	53	130	63	
1"	125	80	23	62	165	72	
1" 1/4	125	97	31,5	69	175	87	
1" 1/2	138	110	31,5	80	195	97	
2"	165	125	50	86	220	110	

SERIE FULL FLOW | FULL FLOW SERIE

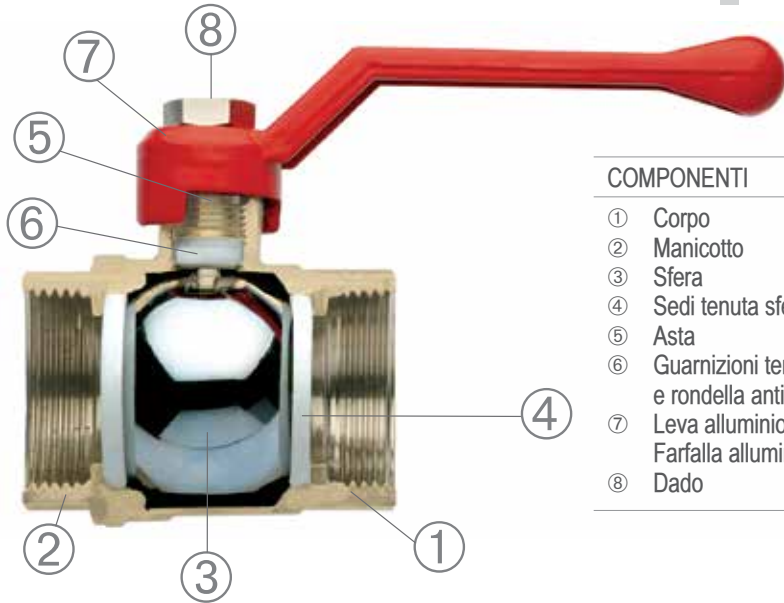

COMPONENTI	COMPONENTS	MATERIALI - MATERIALS
① Corpo	① Body	UNI EN 12165 CW617N
② Manicotto	② End connection	UNI EN 12165 CW617N
③ Sfera	③ Ball	UNI EN 12165 CW617N
④ Sedi tenuta sfera	④ Ball seal	P.T.F.E.
⑤ Asta	⑤ Stem	UNI EN 12164 CW614N
⑥ Guarnizioni tenuta asta e rondella antifrizione	⑥ Stem packing and antifriction ring	P.T.F.E.
⑦ Leva alluminio	⑦ Alu handle	AL fire painted
Farfalla alluminio	Butterfly handle	AL fire painted
⑧ Dado	⑧ Nut	Chrome plated Brass

Condizioni d'esercizio: Temperatura: min -15, max +120 - Pressione nominale: max 40 bar.

Working details: Temperature: min -15, max +120 - Nominal pressure: max 40 bar.

- Passaggio: totale
- Gamma: da 3/8" a 4"
- Attacco femmina: filettatura ISO 228/1 (DIN 259)
- Attacco maschio: filettatura ISO 228/1 (DIN 259)
- Codolo e dado: filettatura ISO 228/1 (DIN 259)

- Flow: full
- Range: from 3/8" till 4"
- Female thread: threading ISO 228/1 (DIN 259)
- Male thread: threading ISO 228/1 (DIN 259)
- Connection fitting and nut: threading ISO 228/1 (DIN 259)

Diagramma perdite di carico/portata
Load losses/flow rate graph

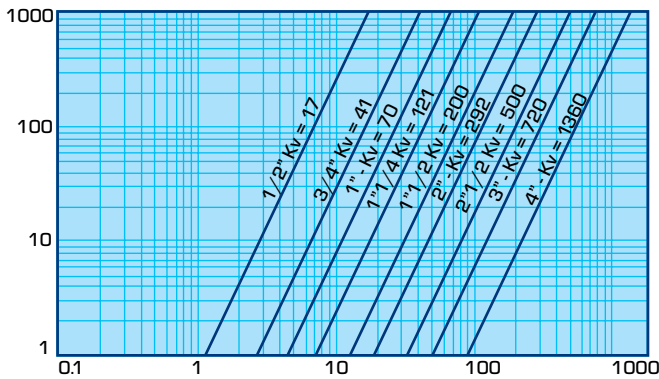

Portata = m³/h di Acqua
Water flow rate = m³/h

Diagramma pressione/temperatura
Pressure/temperature graph

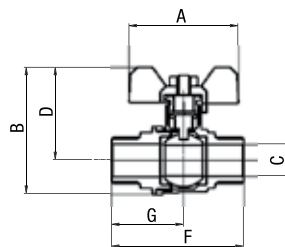
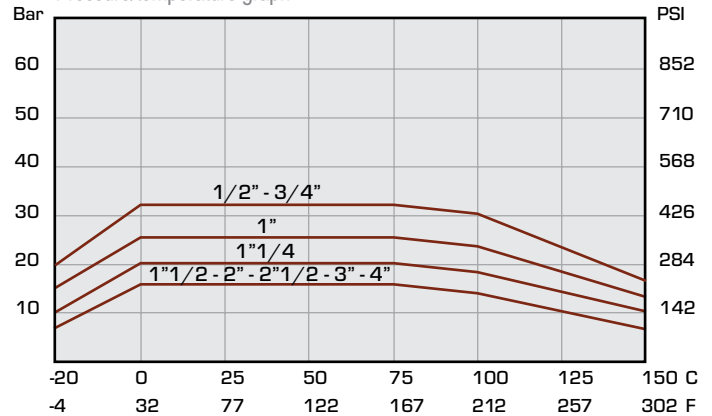

365 MM 1/2" €5,30 3/4" €7,50 1" €12,40

Valvola a sfera M.M., a passaggio totale, maniglia a farfalla.
C.P. full-flow ball valve M.M. with T handle.

	A	B	C	D	E	F	G
1/2"	58,5	53	14,5	38	51	60,5	33
3/4"	61	57,8	18,5	40,5	51	68,5	35,5
1"	71	68,8	23,5	47,8	62	78	40

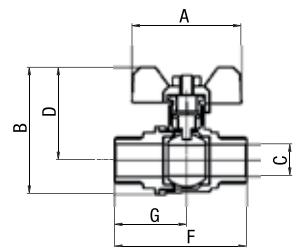

366 1/2" €6,30 3/4" €8,70 1" €14,50 1 1/4" €24,90

Valvola a sfera con bocchettone, a passaggio totale, maniglia a farfalla.
C.P. full-flow ball valve with union connection.

	A	B	C	D	E	F	G
1/2"	78	55	14	38	58	73	48
3/4"	85	60	19	42	58	82	55
1"	98	70	25	45	58	98	65
1 1/4"	110	87	25	60	77	110	72

VALVOLE - VALVES

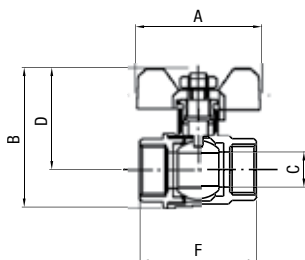

365 FF 1/2" € 4,80 3/4" € 6,60 1" € 10,90

Valvola a sfera F.F., a passaggio totale, maniglia a farfalla.
C.P. full-flow ball valve F.F. with T handle.

	A	B	C	D	E	F	G
1/2"	50	55	14	40		48	
3/4"	50	59	19	42		56	
1"	66	69	25	49		65	

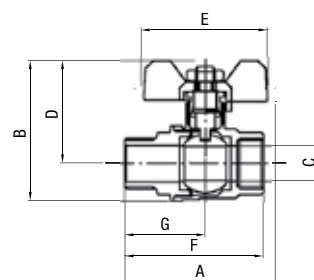

365 MF 1/2" € 5,10 3/4" € 6,90 1" € 11,50

Valvola a sfera M.F., a passaggio totale, maniglia a farfalla.
C.P. full-flow ball valve M.F. with T handle.

	A	B	C	D	E	F	G
1/2"	68	55	14	40	58	57	34
3/4"	65	60	19	43	58	64	37
1"	72	67	24	48	66	72	41

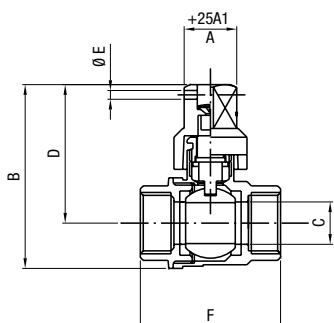

373 FF 1/2" € 5,50 3/4" € 7,60 1" € 11,80

Valvola a sfera F.F., a passaggio totale con quadro 13x13 bloccante piombabile.
C.P. full-flow ball valve F.F. with square cap 13x13.

	A	B	C	D	E	F	G
1/2"	14	63	14	47	3,2	48	
3/4"	14	68	19	50	3,2	56	
1"	16	75	24	53	3,2	65	

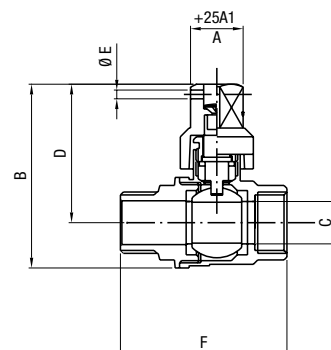

373 MF 1/2" € 6,30 3/4" € 8,40 1" € 12,90

Valvola a sfera M.F., a passaggio totale con quadro 13x13 bloccante piombabile.
C.P. full-flow ball valve M.F. with square cap 13x13.

	A	B	C	D	E	F	G
1/2"	14	65	14	47	3,2	64	
3/4"	14	68	19	50	3,2	63	
1"	16	75	24	53	3,2	71	

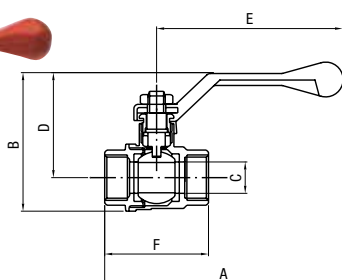

371 3/8" € 3,80 1/2" € 4,80 3/4" € 6,60 1" € 10,90 1 1/4" € 17,30
1 1/2" € 25,20 2" € 37,80 2 1/2" € 82,50 3" € 106,40 4" € 189,70

Valvola a sfera F.F., a passaggio totale, maniglia a leva.
C.P. full-flow ball valve F.F. with lever handle.

	A	B	C	D	E	F	G
3/8"	96	50	10	38	76	40	
1/2"	110	57	14	42	85	48	
3/4"	113	66	19	50	85	56	
1"	130	75	24	52	98	65	
1 1/4"	155	90	31	68	115	78	
1 1/2"	178	110	39	80	130	95	
2"	183	123	50	85	132	102	
2 1/2"	296	170	60	110	225	136	
3"	305	180	70	120	230	150	
4"	320	205	90	135	230	190	

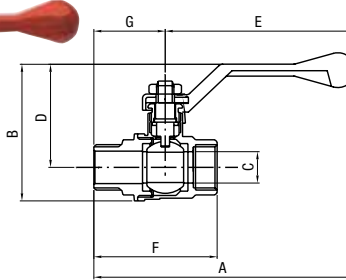

370 1/2" € 5,10 3/4" € 6,90 1" € 11,50
1 1/4" € 18,70 1 1/2" € 24,90 2" € 38,80

Valvola a sfera M.F., a passaggio totale, maniglia a leva.
C.P. full-flow ball valve M.F. with lever handle.

	A	B	C	D	E	F	G
1/2"	117	58	14	43	85	57	34
3/4"	120	62	19	44	85	63	37
1"	135	75	24	53	96	72	41
1 1/4"	165	93	30	68	118	88	50
1 1/2"	186	110	40	80	132	98	56
2"	195	125	50	83	132	112	62

MINUTERIA
MINUTERY

VALVOLE
VALVES

RACCORDERIA
FITTINGS

ACCESSORI
ACCESSORIES

COMPONENTI PLASTICI
PLASTIC COMPONENTS

SERIE STANDARD | STANDARD SERIE

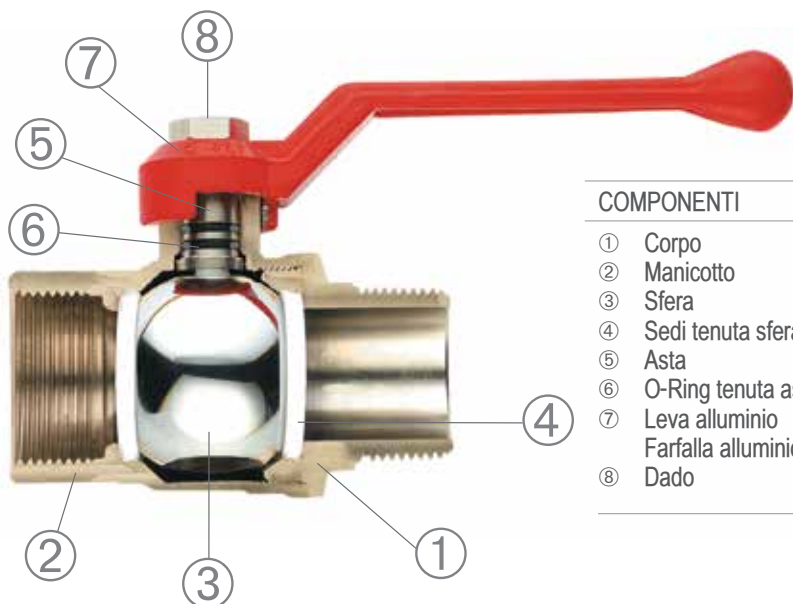

COMPONENTI	COMPONENTS	MATERIALI - MATERIALS
① Corpo	① Body	UNI EN 12165 CW617N
② Manicotto	② End connection	UNI EN 12165 CW617N
③ Sfera	③ Ball	UNI EN 12165 CW617N
④ Sedi tenuta sfera	④ Ball seal	P.T.F.E.
⑤ Asta	⑤ Stem	UNI EN 12164 CW614N
⑥ O-Ring tenuta asta	⑥ Rod seal O-Ring	NBR 70 Sh A (ASTM D 2240)
⑦ Leva alluminio	⑦ Alu handle	AL fire painted
Farfalla alluminio	Butterfly handle	AL fire painted
⑧ Dado	⑧ Nut	Chrome plated Brass

Condizioni d'esercizio: Temperatura: min -15, max +120 - Pressione nominale: max 40 bar.

Working details: Temperature: min -15, max +120 - Nominal pressure: max 40 bar.

- Passaggio: standard
- Gamma: da 1/2" a 2"
- Attacco femmina: filettatura ISO 228/1 (DIN 259)
- Attacco maschio: filettatura ISO 228/1 (DIN 259)

- Flow: standard
- Range: from 1/2" to 2"
- Female thread: threading ISO 228/1 (DIN 259)
- Male thread: threading ISO 228/1 (DIN 259)

Diagramma perdite di carico/portata
Load losses/flow rate graph

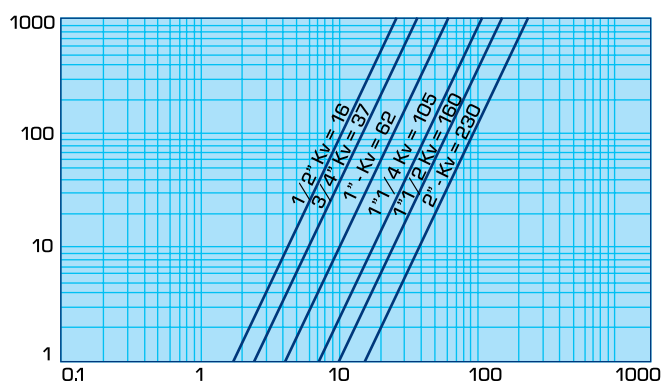

Portata = m³/h di Acqua
Water flow rate = m³/h

Diagramma pressione/temperatura
Pressure/temperature graph

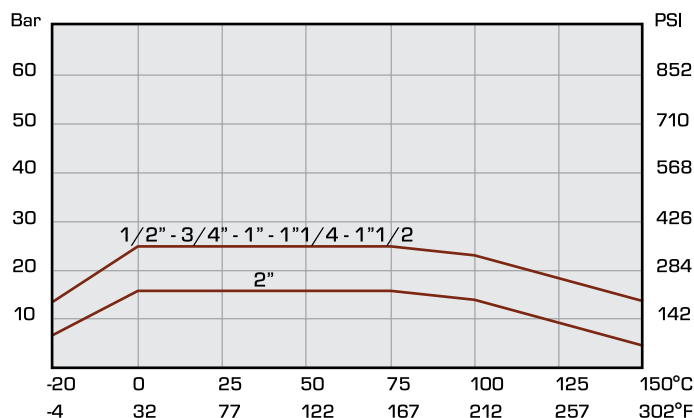

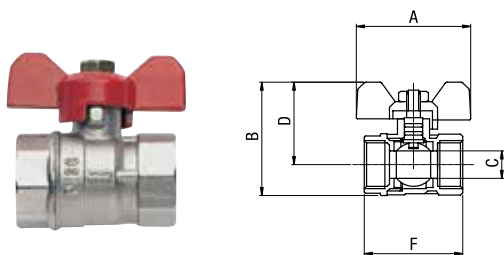

363 FF 1/2 €4,10 3/4 €5,60 1" €10,50

Valvola a sfera F.F., a passaggio standard, maniglia a farfalla, 1/2, 3/4, 1".
C.P. standard-flow ball valve F.F. with T handle, 1/2, 3/4, 1".

	A	B	C	D	E	F	G
1/2"	47	50	13,5	36	50	45	
3/4"	52	59	18	42	50	52	
1"	64	72	23	51	65	63	

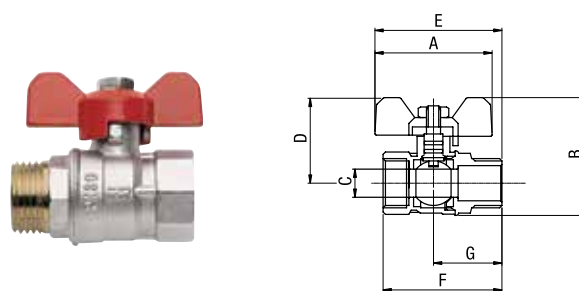

363 MF 1/2 €4,40 3/4 €6,20 1" €10,90

Valvola a sfera M.F., a passaggio standard, maniglia a farfalla, 1/2, 3/4, 1".
C.P. standard-flow ball valve M.F. with T handle, 1/2, 3/4, 1".

	A	B	C	D	E	F	G
1/2"	47	50	13,5	36	50	45	
3/4"	52	59	18	42	50	52	
1"	64	72	23	51	65	63	

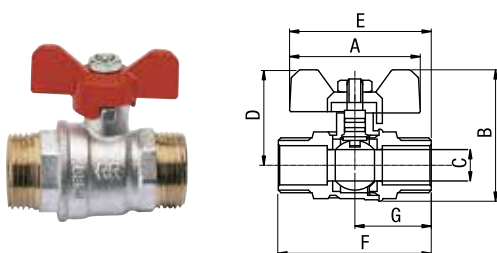

363 MM 1/2 €4,60 3/4 €6,40 1" €11,40

Valvola a sfera M.M., a passaggio standard, maniglia a farfalla, 1/2, 3/4, 1".
C.P. standard-flow ball valve M.M. with T handle, 1/2, 3/4, 1".

	A	B	C	D	E	F	G
1/2"	51,5	51,8	13,8	37	54,6	53	29,2
3/4"	51,5	58,5	17,8	41	58,5	59,5	32,8
1"	63	71,5	23,5	50	71,3	77,5	40,5

SERIE REDUCE FLOW | REDUCE FLOW SERIE

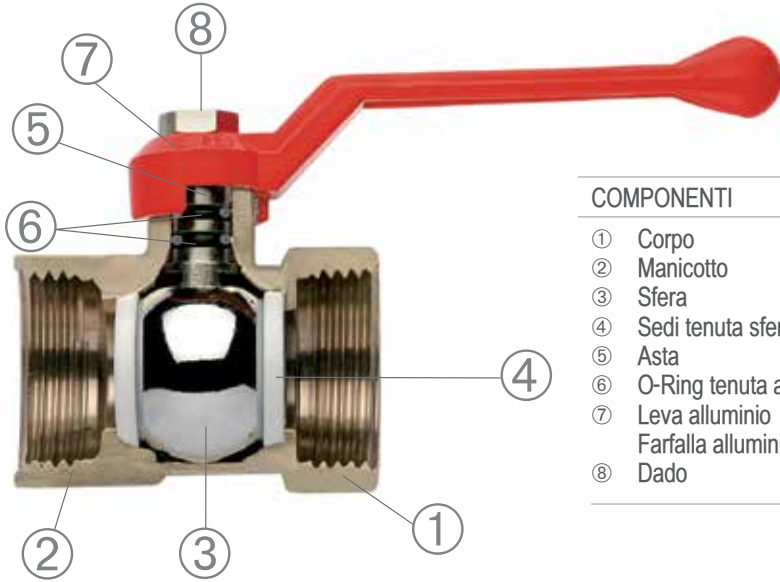

COMPONENTI	COMPONENTS	MATERIALI - MATERIALS
① Corpo	① Body	UNI EN 12165 CW617N
② Manicotto	② End connection	UNI EN 12165 CW617N
③ Sfera	③ Ball	UNI EN 12165 CW617N
④ Sedi tenuta sfera	④ Ball seal	P.T.F.E.
⑤ Asta	⑤ Stem	UNI EN 12164 CW614N
⑥ O-Ring tenuta asta	⑥ Rod seal O-Ring	NBR 70 Sh A (ASTM D 2240)
⑦ Leva alluminio	⑦ Alu handle	AL fire painted
Farfalla alluminio	Butterfly handle	AL fire painted
⑧ Dado	⑧ Nut	Chrome plated Brass

Condizioni d'esercizio: Temperatura: min -15, max +120 - Pressione nominale: max 40 bar.

Working details: Temperature: min -15, max +120 - Nominal pressure: max 40 bar.

- Passaggio: ridotto
- Gamma: da 1/2" a 4"
- Attacco femmina: filettatura ISO 228/1 (DIN 259)
- Attacco maschio: filettatura ISO 228/1 (DIN 259)

- Flow: reduced
- Range: from 1/2" to 4"
- Female thread: threading ISO 228/1 (DIN 259)
- Male thread: threading ISO 228/1 (DIN 259)

Diagramma perdite di carico/portata
Load losses/flow rate graph

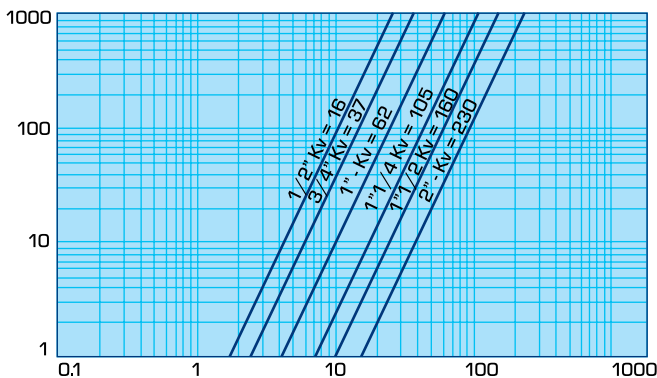

Portata = m³/h di Acqua
Water flow rate = m³/h

Diagramma pressione/temperatura
Pressure/temperature graph

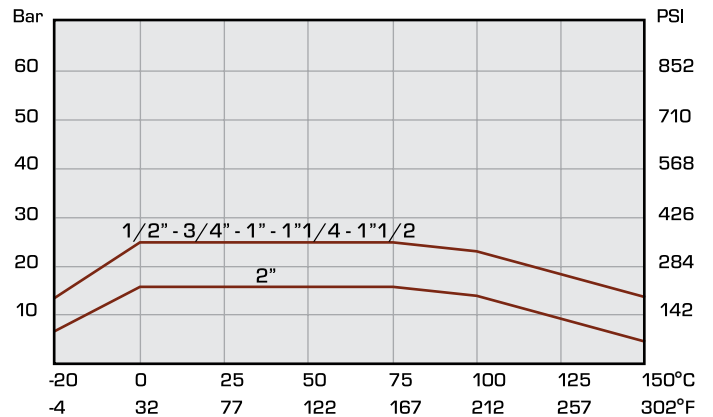

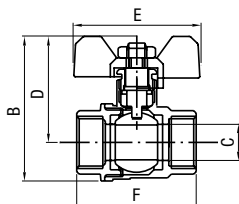

368 FF 1/2" € 4,00 3/4" € 5,70 1" € 9,50

Valvola a sfera F.F. maniglia a farfalla.
C.P. ball valve F.F., with T handle.

	A	B	C	D	E	F	G
1/2"		47		33	58	44	
3/4"		53		36	58	48	
1"		61		42	67	60	

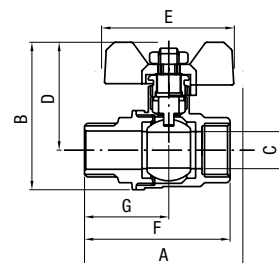

368 MF 1/2" € 4,20 3/4" € 6,00

Valvola a sfera F.F. maniglia a farfalla.
C.P. ball valve F.F., with T handle.

	A	B	C	D	E	F	G
1/2"	61	46	12	33	58	53	32
3/4"	64	53	15	36	58	58	34

VALVOLE | VALVES

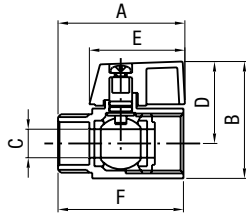

372 MF 1/4 € 4,00 3/8 € 4,10 1/2 € 4,30

Valvola minisfera M.F., con maniglia nera.
C.P. mini ball valve M.F. with black handle.

	A	B	C	D	E	F	G
1/4"	42	38	7,5	28	33	41	
3/8"	42	38	8	28	33	41	
1/2"	45	40	10	28	33	44	

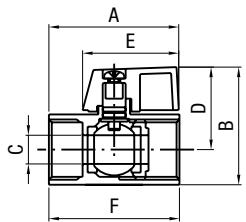

372 FF 1/4 € 4,30 3/8 € 4,40 1/2 € 4,80

Valvola minisfera F.F., con maniglia nera.
C.P. mini ball valve F.F. with black handle.

	A	B	C	D	E	F	G
1/4"	44	38	7,5	28	33	42	
3/8"	44	38	8	28	33	42	
1/2"	45	40	10	28	33	45	

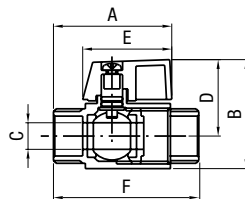

372 MM 1/4 € 4,90 3/8 € 5,10 1/2 € 6,00

Valvola minisfera M.M., con maniglia nera.
C.P. mini ball valve M.M. with black handle.

	A	B	C	D	E	F	G
1/4"	42	38	7,5	28	33	54	
3/8"	42	38	8	28	33	55	
1/2"	45	40	10	28	33	59	

Condizioni d'esercizio: Temperatura: min -15, max +120 - Pressione nominale: max 10 bar.
Working details: Temperature: min -15, max +120 - Nominal pressure: max 10 bar.



372 MF NC 1/2 € 4,60

Valvola minisfera M.F. maniglia cromata e nera, 1/2.
C.P. mini ball valve M.F. with two handles chromed and black, 1/2.



372 FF NC 1/2 € 5,10

Valvola minisfera F.F. maniglia cromata e nera, 1/2.
C.P. mini ball valve F.F. with two handles chromed and black, 1/2.



372 MF RB 1/2 € 4,60

Valvola minisfera M.F. maniglia rossa e blu, 1/2.
C.P. mini ball valve M.F. with two handles red and blue, 1/2.



372 FF RB 1/2 € 5,10

Valvola minisfera F.F. maniglia rossa e blu, 1/2.
C.P. mini ball valve F.F. with two handles red and blue, 1/2.



376 FI

Valvola a sfera con filtro, attacchi per manometro e scarico, con raccordo girevole da 1/2.
Ball valve with filter and connections for manometer and drain, with swivelling nut 1/2.

1/2 € 28,10

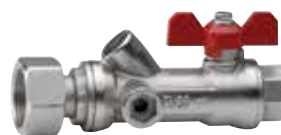

376 NR

Valvola a sfera con valvolina di non ritorno, con attacchi per manometro e scarico, con raccordo girevole da 1/2.
Ball valve with non return valve and connections for manometer and drain, with swivelling nut 1/2.

1/2 € 24,00

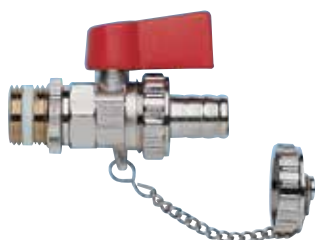
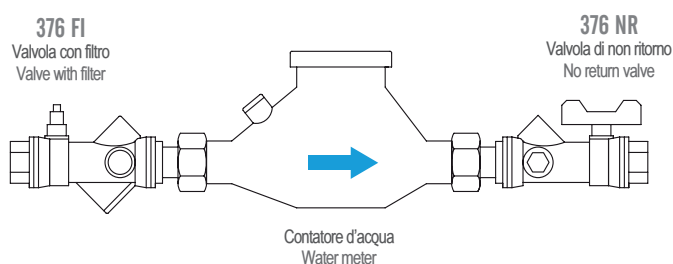

377

Rubinetto scarico caldaia, a sfera, nichelato 1/2.
Drain cock male connection with plug, nickel plated, 1/2.

1/2 € 6,90

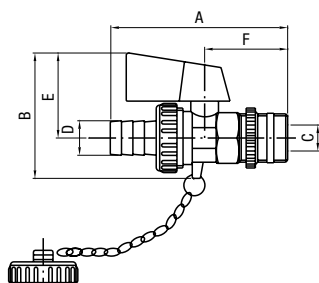

377 OG

Rubinetto scarico caldaia, a sfera, in ottone giallo 1/2.
Drain cock male connection with plug, brass finish, 1/2.

1/2 € 6,60

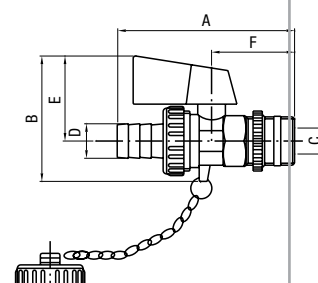

	A	B	C	D	E	F	G
1/2"	77	52	10	15	35	36	

	A	B	C	D	E	F	G
1/2"	77	52	10	15	35	36	

Condizioni d'esercizio: Temperatura: min 0, max +80 - Pressione nominale: max 12 bar.
Working details: Temperature: min 0, max +80 - Nominal pressure: max 12 bar.

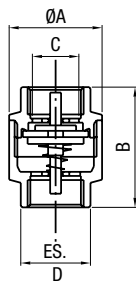

380

Valvola di ritegno.
REMER check valve.

1/2" € 4,70 1"1/4 € 13,20
3/4" € 6,90 1"1/2 € 20,00
1" € 9,20 2" € 30,50

	A	B	C	D	E	F	G
1/2"	35	45	19	25			
3/4"	40	48	24	32			
1"	47	56	30	37			
1" 1/4	59	61	39	46			
1" 1/2	67	70	45	53			
2"	83	75	55	67			

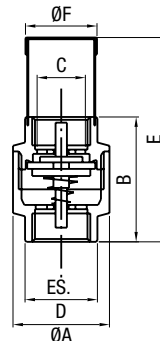

381

Valvola di fondo, con filtro.
REMER foot valve, with filter.

1/2" € 3,70 1"1/4 € 9,70
3/4" € 5,40 1"1/2 € 15,20
1" € 7,30 2" € 23,30

	A	B	C	D	E	F	G
1/2"	34	42	18	25	68	24	
3/4"	44	47	24	31	77	30	
1"	45	52	30	38	89	36	
1" 1/4	59	60	39	46	107	44	
1" 1/2	68	68	44	53	121	54	
2"	84	75	57	67	140	64	

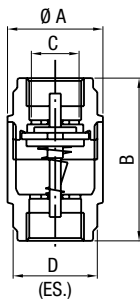

383

Valvola di ritegno STAR.
STAR check valve.

1/2" € 6,40 1"1/4 € 22,10
3/4" € 9,40 1"1/2 € 29,90
1" € 14,50 2" € 47,10

	A	B	C	D	E	F	G
1/2"	33	54	19	27			
3/4"	40	65	24	33			
1"	48	75	30	40			
1" 1/4	60	73	39	50			
1" 1/2	70	87	45	55			
2"	86	94	56	67			



384

Filtro per valvola STAR 1/2, 3/4,
1", 1"1/4, 1"1/2, 2".
Filter for STAR check valve 1/2,
3/4, 1", 1"1/4, 1"1/2, 2".

1/2 € 1,30 1"1/4 € 2,00
3/4 € 1,50 1"1/2 € 2,50
1" € 1,60 2" € 3,20

Condizioni d'esercizio: Temperatura: min 0, max +80 - Pressione nominale: max 12 bar.
Working details: Temperature: min 0, max +80 - Nominal pressure: max 12 bar.



385

Valvola di ritegno.
Foot valve, measures from 3/4 to 2".

3/4 € 9,30 1"1/2 € 22,30
1" € 11,70 2" € 33,90
1"1/4 € 18,30



388

Valvola a clapet con tenuta gomma, 1/2", 3/4", 1".
Swing check valve, with rubber sealing, from 1/2"
to 1".

1/2 € 8,80 1" € 19,20
3/4 € 13,80

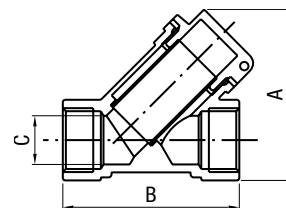

389

Filtro a "Y" in ottone, con rete 400 micron.
"Y" brass filter, with 400 micron strainer.

1/2 € 4,60 1"1/4 € 18,10
3/4 € 7,10 1"1/2 € 27,20
1" € 10,10 2" € 44,20

	A	B	C	D	E	F	G
1/2"	63	55	15				
3/4"	67	70	20				
1"	75	76	25				
1" 1/4	89	99	32				
1" 1/2	100	107	40				
2"	125	126	50				

Condizioni d'esercizio: Temperatura: min 0, max +100 - Pressione nominale: max 20 bar.
Working details: Temperature: min 0, max +100 - Nominal pressure: max 20 bar.

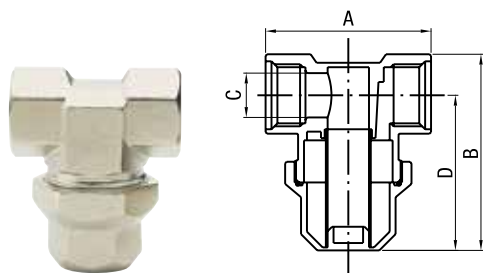

390 FF 1/2 €10,70 3/4 €16,20

Filtro di linea in ottone nichelato, con rete 400 micron, F.F.
In-line filter in nickel-plated brass, with 400 micron strainer, F.F.

	A	B	C	D	E	F	G
1/2"	60	70	13,5	54			
3/4"	71	74	18	55			

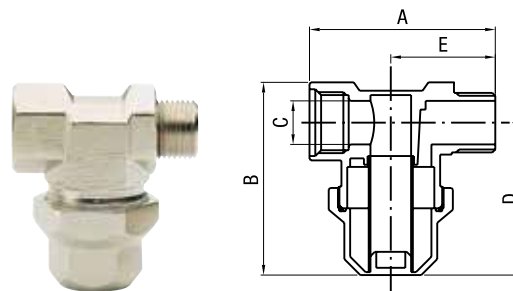

390 MF 1/2 €10,70 3/4 €16,20

Filtro di linea in ottone nichelato, con rete 400 micron, M.F.
In-line filter in nickel-plated brass, with 400 micron strainer, M.F.

	A	B	C	D	E	F	G
1/2"	66	70	13,5	54	36		
3/4"	74	72	18	54	40		

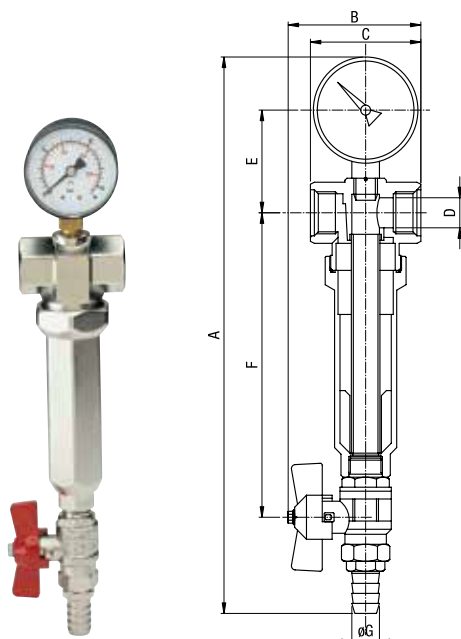

392 1/2 €40,40 3/4 €49,90

Filtro autopulente per fluidi, con rete 100 micron, 1/2, 3/4.
Self-cleaning filter for fluids, 100 micron strainer, 1/2, 3/4.

	A	B	C	D	E	F	G
1/2"	290	70	60	19	60	157	14
3/4"	290	77	60	24	62	150	14



397 €1,30

Tubo gas a norme UNI CIG 7140 - IMQ, Ø 8x13, per gas liquido GPL, in rotoli da mt 50.
Tube for liquid gas GPL, UNI CIG 7140 and IMQ standard rules, Ø 13x8mm, in rolls of 50 meters.



398 €2,20

Tubo gas a norme UNI CIG 7140 - IMQ, Ø 13x20, per gas METANO, in rotoli da mt 50.
Tube for natural gas, UNI CIG 7140 and IMQ standard rules, Ø 13x20 mm, in rolls of 50 meters.

MINUTERIA
MINUTERY

VALVOLE
VALVES

RACCORDERIA
FITTINGS

ACCESSORI
ACCESSORIES

COMPONENTI PLASTICI
PLASTIC COMPONENTS

SERIE YELLOW | YELLOW SERIE



400 FF

Tubo flessibile per gas, FF, conforme alla norma EN14800, tubo interno in acciaio inox, ricoperto da trecciatura inox e rivestito da una guaina in pvc.
Flexible tube for gas, FF, conform to EN14800, internal tube in stainless steel, external braided in stainless steel and covered in pvc.

cm	50	75	100	125	150	200
	€ 25,00	€ 29,50	€ 31,90	€ 34,80	€ 35,80	€ 37,50



400 MF

Tubo flessibile per gas, MF, conforme alla norma EN14800, tubo interno in acciaio inox, ricoperto da trecciatura inox e rivestito da una guaina in pvc.
Flexible tube for gas, MF, conform to EN14800, internal tube in stainless steel, external braided in stainless steel and covered in pvc..

cm	50	75	100	125	150	200
	€ 25,00	€ 29,50	€ 31,90	€ 34,80	€ 35,80	€ 37,50

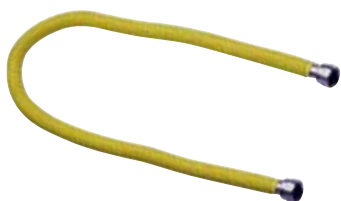

400 FF RI

prodotto non vendibile in italia

Tubo gas inox estensibile ricoperto in polietilene termoretraibile a norma UNI CIG 9891 con marchio IMQ, per collegamento di apparecchiature domestiche.
Flexible extensible stainless steel hose, suitable for domestic use gas connections, in accordance with UNI-CIG 9891, IMQ, covered with yellow thermoshrinking sleeving.

1/2 FF	50-100 cm	75-150 cm	100-200 cm
	€ 18,30	€ 22,00	€ 25,70



400 MF RI

prodotto non vendibile in italia

Tubo gas inox estensibile ricoperto in polietilene termoretraibile a norma UNI CIG 9891 con marchio IMQ, per collegamento di apparecchiature domestiche.
Flexible extensible stainless steel hose, suitable for domestic use gas connections, in accordance with UNI-CIG 9891, IMQ, covered with yellow thermoshrinking sleeving .

1/2 MF	50-100 cm	75-150 cm	100-200 cm
	€ 18,30	€ 22,00	€ 25,70



440

Tubo inox estensibile antivibrante, adatto per gas, acqua, olii, acidi, aria, vapore.
Stainless steel extensible anti-vibration pipe, suitable for gas, water, oils, acids, air, steam.

	Lunghezza - Lenght mm 110-210	Lunghezza - Lenght mm 200-410
1/2 MF	€ 9,80	€ 11,80
3/4 MF	€ 14,20	€ 16,50
1" MF	€ 20,50	€ 22,50



440 RI

Tubo inox estensibile rivestito in polietilene termoretraibile.
Stainless steel extensible pipe, covered with heat-shrinkable polyethylene.

	Lunghezza - Lenght mm 110-210	Lunghezza - Lenght mm 200-410
1/2 MF	€ 12,40	€ 15,00
3/4 MF	€ 16,80	€ 20,70



400 GU € 0,08
Guarnizione in alluminio, 1/2 per art. 400.
Washer in aluminium, 1/2 for art. 400.



400 RA € 9,20
Raccordo maschio da 1/2".
Rackord male 1/2" for art. 400.



400 CH € 4,50
Maniglia con filetto da 1/2" maschio per estendere l'art. 400, più chiave di fissaggio.
Lever with 1/2" male thread to extend art. 400 and its fixing key.

MINUTERIA
MINUTERY

VALVOLE
VALVES

RACCORDERIA
FITTINGS

ACCESSORI
ACCESSORIES

COMPONENTI PLASTICI
PLASTIC COMPONENTS



401 1/2 €17,10
Rubinetto a sfera a squadra per gas metano, cromato M, 1/2.
C.P. angle ball valve for natural gas, 1/2M.



402 1/2 €17,10
Rubinetto a sfera a squadra per gas metano, cromato F, 1/2.
C.P. angle ball valve for natural gas, 1/2F.



403 1/2 €17,10
Rubinetto a sfera a squadra per gas liquido GPL, cromato M, 1/2.
C.P. angle ball valve for liquid gas GPL, 1/2M.



404 1/2 €17,10
Rubinetto a sfera a squadra per gas liquido GPL, cromato F, 1/2.
C.P. angle ball valve for liquid gas GPL, 1/2F.



405 1/2 €17,10
Rubinetto a sfera diritto per gas metano, cromato M, 1/2.
C.P. straight ball valve for natural gas, 1/2M.



406 1/2 €17,10
Rubinetto a sfera diritto per gas metano, cromato F, 1/2.
C.P. straight ball valve for natural gas, 1/2F.



407 1/2 €17,10
Rubinetto a sfera diritto per gas liquido GPL, cromato M, 1/2.
C.P. straight ball valve for liquid gas GPL, 1/2M.



408 1/2 €17,10
Rubinetto a sfera diritto per gas liquido GPL, cromato F, 1/2.
C.P. straight ball valve for liquid gas GPL, 1/2F.



399 1/2 €9,30
Rubinetto gas a sfera a squadra passaggio mm 12,5 con maniglia a farfalla, 1/2 MM.
Angle ball valve for natural gas with T handle, flow Ø 12,5, 1/2M.



411 M 1/2 €14,20
Rubinetto a sfera a squadra per gas, con dado girevole, cromato, M 1/2.
C.P. angle ball valve for gas, with swivelling nut, M 1/2.



411 F 1/2 €14,20
Rubinetto a sfera a squadra per gas, con dado girevole, cromato, F 1/2.
C.P. angle ball valve for gas, with swivelling nut, F 1/2.



RACCORDERIA FITTINGS



RACCORDERIA - FITTINGS

MINUTERIA
MINUTERY

VALVOLE
VALVES

RACCORDERIA
FITTINGS

ACCESSORI
ACCESSORIES

COMPONENTI PLASTICI
PLASTIC COMPONENTS



RACCORDERIA - FITTINGS



413 N 1/2 € 5,40
Valvola sicurezza scaldabagno normale MF, 1/2.
Safety valve for water heaters, normal type, MF 1/2.



413 P8 1/2 € 8,40
Valvola sicurezza scaldabagno pesante tarata 8 atmosfere MF 3/8, 1/2.
Safety valve for water heaters, heavy type, set for 8 atmospheres, MF, 3/8, 1/2.



412 1/2 € 10,90
Valvola sicurezza scaldabagno pesante MF, 1/2.
Safety valve for water heaters, heavy type, MF 1/2.



415 1/2 € 22,40
Riduttore di pressione nichelato FF 1/2.
Nickel plated brass pressure reducer, FF 1/2.



415 CB
1/2 MM € 53,20 3/4 MM € 57,20 1" MM € 106,40
1/2 MF € 54,50 3/4 MF € 58,50 1" MF € 106,40
1/2 FF € 54,50 3/4 FF € 58,50 1" FF € 106,40
Riduttore di pressione in ottone giallo con bocchettone.
Yellow brass pressure reducer, with union connection.

DIMENSIONI - SIZES			
1/2Mx1/2M	1/2Mx1/2F	1/2Fx1/2F	1/2Mx3/4M
1/2Mx3/4F	1/2Fx3/4M	1/2Fx3/4F	3/4Mx3/4M
3/4Mx3/4F	3/4Fx3/4F	1"Mx1"M	1"Mx1"F
1"Fx1"F	1"1/4Mx1"1/4M	1"1/4Mx1"1/4F	1"1/4Fx1"1/4F



418 1/4 € 5,00
Manometro Ø mm 63, con attacco radiale 1/4, 10 bar.
Pressure gauge Ø 63 mm, 1/4" radial connection, 10 bar.



418 P 1/4 € 5,20
Manometro Ø mm 63, con attacco posteriore (assiale) 1/4, 10 bar.
Pressure gauge Ø 63 mm, with rear connection (axial) 1/4, 10 bar.



433
Valvola sfiato aria automatica con galleggiante 3/8, 1/2.
Automatic drain plug for radiator, with floating system, 3/8, 1/2.

3/8	1/2
€ 8,50	€ 8,50



420 L 1" € 10,40
Raccordo a 5 vie per pompa-autoclave, lunghezza mm 92, 1".
5 Ways connector for pumps and tanks, length 92 mm, 1".



461
Bocchettone a 3 pezzi diritto, in ottone giallo.
Straight coupler in 3 pieces, yellow brass.

1/2	3/4	1"	1"1/4
€ 3,00	€ 5,10	€ 9,70	€ 11,80



461 CR
Bocchettone a 3 pezzi diritto, in ottone cromato.
Straight coupler in 3 pieces, C.P. brass.

1/2	3/4	1"	1"1/4
€ 3,20	€ 5,50	€ 10,20	€ 12,70



462
Bocchettone a 3 pezzi curvo, in ottone giallo.
Angle coupler in 3 pieces, yellow brass.

1/2	3/4	1"	1"1/4
€ 4,30	€ 6,50	€ 11,70	€ 17,60



462 CR
Bocchettone a 3 pezzi curvo, in ottone cromato.
Angle coupler in 3 pieces, C.P. brass.

1/2	3/4	1"	1"1/4
€ 4,60	€ 7,10	€ 12,40	€ 18,80



471
Raccordo per cassone con tappo.
Flanged connector for cistern with plug.

1/2	3/4	1"
€ 4,80	€ 7,40	€ 10,50



473
Raccordo per cassone diritto.
Straight connector for cistern.

1/2	3/4	1"
€ 7,30	€ 11,10	€ 15,60
1"1/4	1"1/2	2"
€ 18,90	€ 25,10	€ 38,40



472
Raccordo per cassone con codulo.
Flanged connector for cistern with union.

1/2	3/4	1"
€ 6,40	€ 9,00	€ 12,40



474
Controdado con flangia.
Backnut in brass.

1/2	3/4	1"
€ 1,00	€ 2,00	€ 2,30

RACCORDI IN OTTONE - BRASS FITTINGS



451
Gomito M.F. in ottone cromato.
Elbow M.F., in C.P. brass.

M.F.	3/8	1/2	3/4	1"	1 1/4	1 1/2	2"
€	2,50	3,10	4,30	6,60	12,90	19,00	36,30



451 NP
Gomito M.F. in ottone nichelato.
Elbow M.F., in nickel brass.

M.F.	3/8	1/2	3/4	1"	1 1/4	1 1/2	2"
€	2,00	2,60	3,80	6,10	11,70	18,60	34,80



451 OG
Gomito M.F. in ottone giallo.
Elbow M.F., in yellow brass.

M.F.	3/8	1/2	3/4	1"	1 1/4	1 1/2	2"
€	1,90	2,50	3,60	5,70	11,40	17,20	33,80



452
Gomito F.F. in ottone cromato.
Elbow F.F., in C.P. brass.

F.F.	3/8	1/2	3/4	1"	1 1/4	1 1/2	2"
€	2,60	3,10	4,50	6,60	12,90	16,40	27,80



452 NP
Gomito F.F. in ottone nichelato.
Elbow F.F., in nickel brass.

F.F.	3/8	1/2	3/4	1"	1 1/4	1 1/2	2"
€	2,10	2,60	4,00	6,10	11,70	14,80	26,80



452 OG
Gomito F.F. in ottone giallo.
Elbow F.F., in yellow brass.

F.F.	3/8	1/2	3/4	1"	1 1/4	1 1/2	2"
€	2,00	2,50	3,80	5,70	11,40	14,60	26,20



453
TE in ottone cromato.
Tee in chrome plated brass.

TE	3/8	1/2	3/4	1"	1 1/4	1 1/2	2"
€	2,90	3,30	4,80	7,00	14,20	21,30	33,30



453 NP
TE in ottone nichelato.
Tee in nickel brass.

TE	3/8	1/2	3/4	1"	1 1/4	1 1/2	2"
€	2,50	2,80	4,40	6,50	12,70	19,80	31,20



453 OG
TE in ottone giallo.
Tee in yellow brass.

TE	3/8	1/2	3/4	1"	1 1/4	1 1/2	2"
€	2,35	2,70	4,10	6,10	12,40	19,20	30,50



454
Manicotto F.F. in ottone cromato.
Sleeve F.F. in chrome plated brass.

F.F.	3/8	1/2	3/4	1"	1 1/4	1 1/2	2"
€	1,45	1,60	2,00	3,20	6,60	9,10	11,50



454 NP
Manicotto F.F. in ottone nichelato.
Sleeve F.F. in nickel brass.

F.F.	3/8	1/2	3/4	1"	1 1/4	1 1/2	2"
€	1,30	1,40	1,80	2,90	6,20	8,50	10,80



454 OG
Manicotto F.F. in ottone giallo.
Sleeve F.F. in yellow brass.

F.F.	3/8	1/2	3/4	1"	1 1/4	1 1/2	2"
€	1,23	1,35	1,70	2,70	5,90	8,10	10,40



502
Prolunghe in ottone cromato, con broccia.
C.P. brass extension.

mm	3/8	1/2	3/4	1"
10	€1,15	€1,00	€2,00	
15	€1,35	€1,23	€2,40	€3,60
20	€1,75	€1,45	€3,10	€4,00
25	€2,10	€1,70	€3,75	€4,60
30	€2,45	€1,90	€3,95	€5,50
40	€2,70	€2,35	€4,80	€6,60
50	€3,10	€2,80	€5,70	€7,70
60		€3,90	€6,40	
80		€5,00	€8,10	
100		€5,80	€9,60	



502 OG
Prolunghe in ottone giallo con broccia.
Yellow brass extension.

mm	3/8	1/2	3/4	1"
10	€1,00	€0,85	€1,80	
15	€1,15	€1,06	€2,10	€3,20
20	€1,55	€1,26	€2,80	€3,60
25	€1,90	€1,49	€3,45	€4,10
30	€2,25	€1,70	€3,65	€4,90
40	€2,45	€2,15	€4,50	€5,90
50	€2,80	€2,50	€5,30	€7,00
60		€3,70	€6,00	
80		€4,70	€7,60	
100		€5,30	€9,10	



502 P
Prolunghe in ottone cromato tipo pesante, Ø mm 27, con broccia.
Heavy c.p. brass extension, Ø mm 27.

1/2	10 mm	15 mm	20 mm	25 mm	30 mm	40 mm	50 mm	60 mm	80 mm	100 mm
€	1,30	1,50	1,85	2,20	2,40	3,10	3,70	5,20	6,80	7,90



502 P OG
Prolunghe in ottone giallo tipo pesante Ø mm 27, con broccia.
Heavy yellow brass extension Ø mm 27.

1/2	10 mm	15 mm	20 mm	25 mm	30 mm	40 mm	50 mm	60 mm	80 mm	100 mm
€	1,06	1,32	1,65	1,90	2,20	2,80	3,40	4,90	6,30	7,30

MINUTERIA
MINUTERY

VALVOLE
VALVES

RACCORDERIA
FITTINGS

ACCESSORI
ACCESSORIES

COMPONENTI PLASTICI
PLASTIC COMPONENTS

RACCORDERIA - FITTINGS



506

Prolunghe ridotte in ottone cromato.
Round C.P. brass reduced extension.

1/4x3/8	1/4x1/2	3/8x1/2	3/8x3/4
€ 1,30	€ 1,45	€ 1,25	€ 1,85
1/2x3/4	1/2x1"	1/2x1"1/4	3/4x1"
€ 1,65	€ 3,35	€ 5,70	€ 2,25
3/4x1"1/4	3/4x1"1/2	1"x1"1/4	1"x1"1/2
€ 5,70	€ 7,10	€ 6,50	€ 7,40
1"x2"	1"1/4x1"1/2	1"1/4x2"	1"1/2x2"
€ 11,10	€ 8,30	€ 11,40	€ 11,00



506 NP

Prolunghe ridotte in ottone nichelato.
Round nickel brass reduced extension.

1/4x3/8	1/4x1/2	3/8x1/2	3/8x3/4
€ 1,18	€ 1,32	€ 1,12	€ 1,75
1/2x3/4	1/2x1"	1/2x1"1/4	3/4x1"
€ 1,50	€ 3,10	€ 5,45	€ 1,95
3/4x1"1/4	3/4x1"1/2	1"x1"1/4	1"x1"1/2
€ 5,45	€ 6,85	€ 6,20	€ 7,05
1"x2"	1"1/4x1"1/2	1"1/4x2"	1"1/2x2"
€ 10,70	€ 8,00	€ 11,05	€ 10,60



506 OG

Prolunghe ridotte in ottone giallo.
Round yellow brass reduced extension.

1/4x3/8	1/4x1/2	3/8x1/2	3/8x3/4
€ 1,12	€ 1,26	€ 1,06	€ 1,65
1/2x3/4	1/2x1"	1/2x1"1/4	3/4x1"
€ 1,40	€ 2,95	€ 5,20	€ 1,85
3/4x1"1/4	3/4x1"1/2	1"x1"1/4	1"x1"1/2
€ 5,20	€ 6,50	€ 5,90	€ 6,70
1"x2"	1"1/4x1"1/2	1"1/4x2"	1"1/2x2"
€ 10,20	€ 7,60	€ 10,50	€ 10,10



510

Manicotto ridotto F.F. in ottone cromato.
Reduced sleeve F.F. in C.P. brass.

1/4x3/8	3/8x1/2	3/8x1"	1/2x3/4
€ 1,85	€ 1,90	€ 4,10	€ 2,30
1/2x1"	1/2x1"1/4	1/2x1"1/2	3/4x1"
€ 4,60	€ 7,00	€ 8,80	€ 4,60
3/4x1"1/4	3/4x1"1/2	3/4x2"	1"x1"1/4
€ 7,30	€ 8,60	€ 13,40	€ 7,90
1"x1"1/2	1"x2"	1"1/4x1"1/2	1"1/4x2"
€ 9,60	€ 12,80	€ 9,80	€ 13,40



510 NP

Manicotto ridotto F.F. in ottone nichelato.
Reduced sleeve F.F. in nickel brass.

1/4x3/8	3/8x1/2	3/8x1"	1/2x3/4
€ 1,70	€ 1,75	€ 4,60	€ 2,10
1/2x1"	1/2x1"1/4	1/2x1"1/2	3/4x1"
€ 4,20	€ 6,75	€ 8,60	€ 4,20
3/4x1"1/4	3/4x1"1/2	3/4x2"	1"x1"1/4
€ 7,05	€ 8,30	€ 13,20	€ 7,60
1"x1"1/2	1"x2"	1"1/4x1"1/2	1"1/4x2"
€ 9,20	€ 12,50	€ 9,40	€ 13,20



510 OG

Manicotto ridotto F.F. in ottone giallo.
Reduced sleeve F.F. in yellow brass.

1/4x3/8	3/8x1/2	3/8x1"	1/2x3/4
€ 1,60	€ 1,65	€ 4,40	€ 2,00
1/2x1"	1/2x1"1/4	1/2x1"1/2	3/4x1"
€ 4,00	€ 6,40	€ 8,20	€ 4,00
3/4x1"1/4	3/4x1"1/2	3/4x2"	1"x1"1/4
€ 6,70	€ 7,90	€ 12,50	€ 7,20
1"x1"1/2	1"x2"	1"1/4x1"1/2	1"1/4x2"
€ 8,70	€ 11,90	€ 8,90	€ 12,50



511

Riduzioni esagonali in ottone cromato.
Hexagonal reducing piece in chrome plated brass.

1/4x3/8	1/4x1/2	1/4x3/4	3/8x1/2
€ 0,69	€ 1,20	€ 1,80	€ 0,86
3/8x3/4	3/8x1"	1/2x3/4	1/2x1"
€ 1,75	€ 3,35	€ 1,45	€ 3,00
1/2x1"1/4	1/2x1"1/2	1/2x2"	3/4x1"
€ 7,20	€ 9,40	€ 14,50	€ 2,25
3/4x1"1/4	3/4x1"1/2	3/4x2"	1"x1"1/4
€ 6,70	€ 9,10	€ 13,20	€ 5,80
1"x1"1/2	1"x2"	1"1/4x1"1/2	1"1/4x2"
€ 8,00	€ 12,10	€ 6,00	€ 10,30



511 NP

Riduzioni esagonali in ottone nichelato.
Hexagonal reducing piece in nickel brass.

1/4x3/8	1/4x1/2	1/4x3/4	3/8x1/2
€ 0,55	€ 1,05	€ 1,65	€ 0,70
3/8x3/4	3/8x1"	1/2x3/4	1/2x1"
€ 1,48	€ 3,15	€ 1,26	€ 2,85
1/2x1"1/4	1/2x1"1/2	1/2x2"	3/4x1"
€ 6,90	€ 9,30	€ 14,50	€ 2,05
3/4x1"1/4	3/4x1"1/2	3/4x2"	1"x1"1/4
€ 6,40	€ 8,70	€ 13,00	€ 5,20
1"x1"1/2	1"x2"	1"1/4x1"1/2	1"1/4x2"
€ 7,50	€ 11,90	€ 5,40	€ 9,90



511 OG

Riduzioni esagonali in ottone giallo.
Hexagonal reducing piece in yellow brass.

1/4x3/8	1/4x1/2	1/4x3/4	3/8x1/2
€ 0,52	€ 0,98	€ 1,55	€ 0,64
3/8x3/4	3/8x1"	1/2x3/4	1/2x1"
€ 1,40	€ 3,00	€ 1,20	€ 2,70
1/2x1"1/4	1/2x1"1/2	1/2x2"	3/4x1"
€ 6,60	€ 8,80	€ 13,80	€ 1,95
3/4x1"1/4	3/4x1"1/2	3/4x2"	1"x1"1/4
€ 6,10	€ 8,30	€ 12,40	€ 4,90
1"x1"1/2	1"x2"	1"1/4x1"1/2	1"1/4x2"
€ 7,10	€ 11,20	€ 5,10	€ 9,30



515

Viti doppie ridotte in ottone cromato.
Reduced nipple in C.P. brass.

1/4x3/8	1/4x1/2	3/8x1/2	3/8x3/4
€ 1,18	€ 1,42	€ 1,18	€ 2,10
1/2x3/4	1/2x1"	1/2x1"1/4	3/4x1"
€ 1,90	€ 4,60	€ 6,20	€ 3,90
3/4x1"1/4	3/4x1"1/2	1"x1"1/4	1"x1"1/2
€ 6,10	€ 9,30	€ 7,65	€ 9,00
1"x2"	1"1/4x1"1/2	1"1/4x2"	1"1/2x2"
€ 12,00	€ 8,90	€ 11,90	€ 11,70



515 NP

Viti doppie ridotte in ottone nichelato.
Reduced nipple in nickel brass.

1/4x3/8	1/4x1/2	3/8x1/2	3/8x3/4
€ 1,03	€ 1,28	€ 1,00	€ 1,90
1/2x3/4	1/2x1"	1/2x1"1/4	3/4x1"
€ 1,70	€ 4,00	€ 5,70	€ 3,30
3/4x1"1/4	3/4x1"1/2	1"x1"1/4	1"x1"1/2
€ 5,50	€ 8,80	€ 7,10	€ 8,60
1"x2"	1"1/4x1"1/2	1"1/4x2"	1"1/2x2"
€ 11,60	€ 8,40	€ 11,30	€ 11,10



515 OG

Viti doppie ridotte in ottone giallo.
Reduced nipple in yellow brass.

1/4x3/8	1/4x1/2	3/8x1/2	3/8x3/4
€ 0,98	€ 1,20	€ 0,95	€ 1,80
1/2x3/4	1/2x1"	1/2x1"1/4	3/4x1"
€ 1,60	€ 3,80	€ 5,40	€ 3,10
3/4x1"1/4	3/4x1"1/2	1"x1"1/4	1"x1"1/2
€ 5,20	€ 8,30	€ 6,75	€ 8,10
1"x2"	1"1/4x1"1/2	1"1/4x2"	1"1/2x2"
€ 11,10	€ 8,00	€ 10,80	€ 10,60

RACCORDERIA - FITTINGS

MINUTERIA
MINUTERY

VALVOLE
VALVES

RACCORDERIA
FITTINGS

ACCESSORI
ACCESSORIES

COMPONENTI PLASTICI
PLASTIC COMPONENTS



515L

Viti doppie ridotte in ottone cromato, con 7 filetti.
Reduced nipple in C.P. brass, with 7 threads.

3/8x1/2

€ 2,40

1/2x3/4

€ 4,10



515L NP

Viti doppie ridotte in ottone nichelato, con 7 filetti.
Reduced nipple in nickel brass, with 7 threads.

3/8x1/2

€ 2,20

1/2x3/4

€ 3,90



515L OG

Viti doppie ridotte in ottone giallo, con 7 filetti.
Reduced nipple in yellow brass, with 7 threads.

3/8x1/2

€ 2,10

1/2x3/4

€ 3,70



520

Viti doppie in ottone cromato.
Double nipple in c.p. brass.

3/8 1/2 3/4 1" 1"1/4 1"1/2 2"

€ 0,90 € 1,10 € 1,95 € 3,40 € 7,60 € 8,80 € 10,20



520 NP

Viti doppie in ottone nichelato.
Double nipple in nickel brass.

3/8 1/2 3/4 1" 1"1/4 1"1/2 2"

€ 0,76 € 0,98 € 1,85 € 3,30 € 7,10 € 8,20 € 9,70



520 OG

Viti doppie in ottone giallo.
Double nipple in yellow brass.

3/8 1/2 3/4 1" 1"1/4 1"1/2 2"

€ 0,72 € 0,92 € 1,75 € 3,10 € 6,70 € 7,80 € 9,20



520L

Viti doppie in ottone cromato, con 7 filetti.
Double nipple in c.p. brass, with 7 threads.

1/2

€ 2,50

3/4

€ 4,60



520L NP

Viti doppie in ottone nichelato, con 7 filetti.
Double nipple in nickel brass, with 7 threads.

1/2

€ 2,20

3/4

€ 4,30



520L OG

Viti doppie in ottone giallo, con 7 filetti.
Double nipple in yellow brass, with 7 threads.

1/2

€ 2,10

3/4

€ 4,10



523

Tappi esagonali in ottone cromato.
Hexagonal plug in c. p. brass.

3/8

€ 0,70

1/2

€ 0,89

3/4

€ 1,45

1"

€ 2,30



523 NP

Tappi esagonali in ottone nichelato.
Hexagonal plug in nickel brass.

3/8

€ 0,55

1/2

€ 0,67

3/4

€ 1,28

1"

€ 2,10



523 OG

Tappi esagonali in ottone giallo.
Hexagonal plug in yellow brass.

3/8

€ 0,52

1/2

€ 0,64

3/4

€ 1,20

1"

€ 2,00



524

Calotte esagonali in ottone cromato.
Hexagonal cap in c. p. brass.

3/8

€ 0,58

1/2

€ 0,80

3/4

€ 1,30

1"

€ 1,80



524 NP

Calotte esagonali in ottone nichelato.
Hexagonal cap in nickel brass.

3/8

€ 0,42

1/2

€ 0,62

3/4

€ 1,10

1"

€ 1,60



524 OG

Calotte esagonali in ottone giallo.
Hexagonal cap in yellow brass.

3/8

€ 0,40

1/2

€ 0,58

3/4

€ 1,05

1"

€ 1,50

1"1/4

€ 4,30

1"1/2

€ 5,80

2"

€ 9,10

1"1/4

€ 3,60

1"1/2

€ 5,10

2"

€ 8,40

1"1/4

€ 3,40

1"1/2

€ 4,80

2"

€ 8,00

VITI DOPPIE - DOUBLE NIPPLES



521 1/2 €1,45
Vite doppia in ottone cromato mm 36, 1/2".
Double nipple in c.p. brass mm 36, 1/2".



521 NP 1/2 €1,20
Vite doppia in ottone nichelato mm 36, 1/2".
Double nipple in nickel brass mm 36, 1/2".



521 OG 1/2 €1,15
Vite doppia in ottone giallo mm 36, 1/2".
Double nipple in yellow brass mm 36, 1/2".



521 12L 1/2 €1,95
Vite doppia in ottone cromato prolungata mm 50, 1/2".
Double nipple in c.p. brass mm 50, extended 1/2".



521 NP 12L 1/2 €1,75
Vite doppia prolungata in ottone nichelato mm 50, 1/2".
Double nipple in nickel brass mm 50, extended 1/2".



521 OG 12L 1/2 €1,65
Vite doppia prolungata in ottone giallo mm 50, 1/2".
Double nipple in yellow brass mm 50, extended 1/2".

PORTAGOMMA - HOSE HOLDER



531 1/2 €2,60
Portagomma diritto in ottone cromato Ø 14 mm, attacco M, 1/2.
Straight hose holder in c.p. brass Ø 14 mm, Male connection, 1/2.



532 1/2 €2,70
Portagomma diritto in ottone cromato Ø 14 mm, attacco F, 1/2.
Straight hose holder in c.p. brass Ø 14 mm, Female connection, 1/2.



533 1/2 €2,10
Portagomma diritto in ottone cromato Ø 9 mm, attacco M, 1/2.
Straight hose holder in c.p. brass Ø 9 mm, Male connection, 1/2.



534 1/2 €2,10
Portagomma diritto in ottone cromato Ø 9 mm, attacco F, 1/2.
Straight hose holder in c.p. brass Ø 9 mm, Female connection, 1/2.



536 1/2 €4,10
Portagomma curvo in ottone cromato Ø 15 mm, attacco M, 1/2.
Elbow hose holder in c.p. brass Ø 15 mm, Male connection, 1/2.



537 1/2 €3,50
Portagomma curvo in ottone cromato Ø 15 mm, attacco F, 1/2.
Elbow hose holder in c.p. brass Ø 15 mm, Female connection, 1/2.



538 1/2 €3,40
Portagomma curvo in ottone cromato Ø 10 mm, attacco M, 1/2.
Elbow hose holder in c.p. brass Ø 10 mm, Male connection, 1/2.



539 1/2 €2,90
Portagomma curvo in ottone cromato Ø 10 mm, attacco F, 1/2.
Elbow hose holder in c.p. brass Ø 10 mm, Female connection, 1/2.

RACCORDI - FITTINGS



530 OG

Bariotti in ottone giallo, confezione da 10 pezzi.
Yellow brass extension screws, packing of 10 pieces.

mm	60	80	100	120	150	200	300	500
1/2	€ 2,35	€ 3,00	€ 3,65	€ 4,40	€ 5,50	€ 7,10	€ 10,80	€ 18,30
3/4	€ 3,30	€ 4,30	€ 5,20	€ 6,10	€ 7,60	€ 10,00	€ 15,30	€ 25,70
1"	€ 5,00	€ 6,70	€ 8,50	€ 10,20	€ 11,10	€ 15,50	€ 24,20	€ 42,20



529

Raccordo tutto filettato in ottone cromato.
C.p. brass extension full threaded.

1/2	30 mm	50 mm	60 mm	65 mm	80 mm	100 mm
€	2,30	2,90	3,60	3,90	4,40	4,90



529 OG

Raccordo tutto filettato in ottone giallo.
Yellow brass extension full threaded.

1/2	30 mm	50 mm	60 mm	65 mm	80 mm	100 mm
€	1,80	2,30	2,65	2,80	3,30	3,80

RACCORDI IN ACCIAIO ZINCATO - GALVANIZED FITTINGS



501

Prolunghe in acciaio zincato.
Galvanized steel extensions.

mm	10	15	20	25	30
3/8	€ 0,47	€ 0,52	€ 0,58	€ 0,73	€ 0,80
1/2	€ 0,44	€ 0,46	€ 0,51	€ 0,69	€ 0,72
3/4	€ 0,81	€ 0,86	€ 1,10	€ 1,30	€ 1,40



506 AZ

Prolunghe ridotte in acciaio zincato.
Reduced extension round, galvanized steel.

1/4x3/8	3/8x1/2	1/2x3/4	3/4x1"
€ 0,66	€ 0,61	€ 0,84	€ 1,90



511 AZ

Riduzioni esagonali in acciaio zincato.
Hexagonal reduced extension, galvanized steel.

1/4x3/8	3/8x1/2	1/2x3/4	3/4x1"
€ 0,53	€ 0,62	€ 0,73	€ 1,50



515 AZ

Viti doppie ridotte in acciaio zincato.
Reduced nipple, galvanized steel.

1/4x3/8	3/8x1/2	1/2x3/4	3/4x1"
€ 0,58	€ 0,73	€ 1,30	€ 2,10



520 AZ

Viti doppie esagonali in acciaio zincato.
Hexagonal double nipple in galvanized steel.

1/4"	3/8"	1/2"	3/4"	1"
€ 0,50	€ 0,51	€ 0,52	€ 1,20	€ 2,10



522 AZ

Manicotti FF in acciaio zincato.
Sleeve FF in galvanized steel.

3/8"	1/2"	3/4"
€ 0,66	€ 0,76	€ 1,29



530

Bariotti in acciaio zincato, confezioni da 10 pezzi.
Galvanized steel extension screws, packing of 10 pieces.

mm	60 mm	80 mm	100 mm	120 mm	150 mm	200 mm	300 mm	500 mm
1/2	€ 1,20	€ 1,30	€ 1,30	€ 1,80	€ 1,90	€ 2,20	€ 2,90	€ 5,90
3/4	€ 1,30	€ 1,50	€ 1,60	€ 2,00	€ 2,20	€ 3,20	€ 3,80	€ 5,50
1"	€ 1,80	€ 1,90	€ 2,20	€ 2,60	€ 2,90	€ 3,70	€ 5,00	€ 8,00

MINUTERIA
MINUTERY

VALVOLE
VALVES

RACCORDERIA
FITTINGS

ACCESSORI
ACCESSORIES

COMPONENTI PLASTICI
PLASTIC COMPONENTS

SERIE 495 | 495 SERIE

TUBO MULTISTRATO RR PEX - MULTILAYER PIPE RR PEX



Tubo multistrato RR PEX.
Multilayer pipe RR PEX.



Tubo multistrato RR PEX ricoperto con polietilene espanso, mm 6.
Multilayer pipe RR PEX covered with expanded polyethylene, mm 6.

495

Art.	Dimensione/Size	Rotolo/Rolls m	€
495 16	Ø 16x2 mm	100 m	€ 1,40
495 20	Ø 20x2 mm	100 m	€ 1,90
495 26	Ø 26x3 mm	50 m	€ 3,90
495 32	Ø 32x3 mm	50 m	€ 4,90

495 R

Art.	Dimensione/Size	Rotolo/Rolls m	€
495 16 R	Ø 16x2 mm	50 m	€ 2,20
495 20 R	Ø 20x2 mm	50 m	€ 2,80
495 26 R	Ø 26x3 mm	50 m	€ 5,20

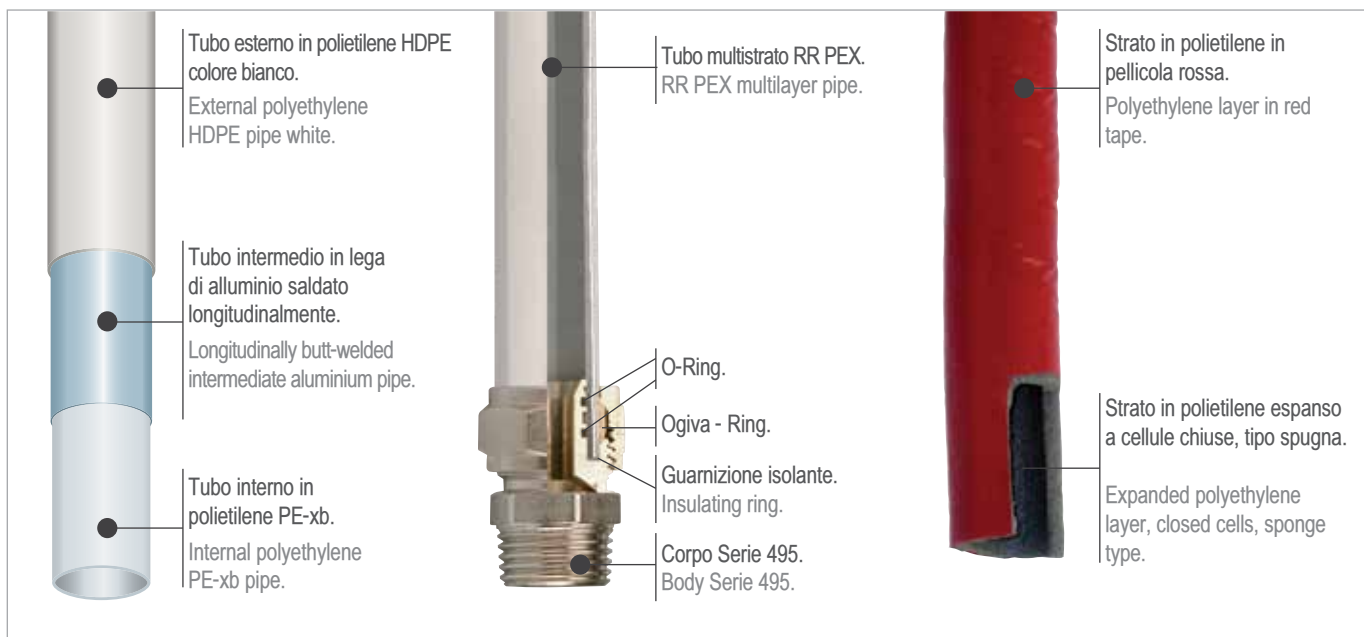

495 CE € 17,80

Cesoia taglia tubo.
Pipe cutter.

Analisi del tubo multistrato RR PEX Secondo UNI 10954-1 Analysis of the multilayer pipe RR PEX Conform to UNI 10954-1

MINUTERIA
MINUTERY

VALVOLE
VALVES

RACCORDERIA
FITTINGS

ACCESSORI
ACCESSORIES

COMPONENTI PLASTICI
PLASTIC COMPONENTS

ESAME DIMENSIONALE

Misure di spessore degli strati del tubo:

Art.	Dn esterno	Dn interno	S parete n	Tolleranza	Strato esterno media Um	Strato intermedio media Um	Strato interno media Um
495 16	16	12	2	± 0,2	700	300	1.000
495 20	20	16	2	± 0,15	680	320	1.000
495 26	26	20	3	± 0,1	1.085	385	1.530
495 32	32	26	3	± 0,15	900	385	1.715

DIMENSIONAL TEST

Measurement of the thickness of the layers:

Gli spessori e le tolleranze degli strati sono conformi a quanto previsto per la serie S, punto 7 UNI 10954/1 prospetti 2/3.

La serie S di appartenenza ad ogni misura è la seguente (16 x 2 = S26) (20 x 2 - 26 x 3 - 32 x 3 corrispondono alla serie S 34,5 / 42.8).

Thicknesses and tolerances of layers are in accordance with the same regulation as S serie, point 7 UNI 10954/1 prospects 2/3.

The S serie belonging to each measure is the following (16 x 2 = S26) (20 x 2 - 26 x 3 - 32 x 3 correspond to S serie 34,5 / 42.8).

Determinazione della resistenza alla pressione idrostatica secondo UNI 10954-1:2004 e caratteristiche meccaniche.

La prova è stata condotta secondo la norma UNI EN 921:1995 nelle seguenti condizioni:

Determination of the resistance to the hydrostatic pressure following UNI 10954-1:2004 and mechanical features.

The test has been driven following the rule UNI EN 921:1995 in following conditions:

Pressione idrostatica impostata	20,5 bar (prevista 19,73)
Classe di appartenenza dichiarata	2
Temperatura di prova impostata	95°C
Natura dell'ambiente di prova	Acqua
Tamponi utilizzati	Tipo A
Lunghezza libera del tubo	200 mm.
Durata della prova	1008 h (prevista 1000 h)
Posizione provino	Verticale

Set hydrostatic pressure	20,5 bar (norm testing up to 19,73)
Declared class of belonging	2
Set test temperature	95°C
Nature of the testing environment	Water
Plugs used	Type A
Free length of the tube	200 mm.
Testing time	1008 h (norm testing 1000 h)
Testing position	Vertical

Incertezza di misura espressa come deviazione std.: pressione ±0,1 bar, temperatura ±1,4°C.

The uncertainty of measure is expressed as derivation from std.: pressure ±0,1 bar, temperature ±1,4°C.

I risultati ottenuti sono i seguenti:

The results obtained are the followings:

REQUISITO PROVA TEST REQUIREMENT	VALORE OTTENUTO VALUE OBTAINED	ESITO DELLA PROVA TEST RESULT	TIPO DI ROTTURA KIND OF BREAKING
NESSUNA ROTTURA PER LA DURATA PROVA NO BREAKING FOR ALL THE TESTING TIME	Nessuna rottura No breaking	Positivo Positive	-- --

Caratteristiche fisiche e chimiche

Grado di reticolazione dello strato interno dei test di controllo eseguito sui campioni a norma UNI EN 579 Art 495 16 = 66,4%_ Art 495 20 = 65,8%_ Art 495 26 = 65,7% _ Art 495 32 = 65,6%.

Grado di reticolazione dello strato esterno dei test di controllo eseguiti sui campioni a norma UNI EN 579 Art 495 16 =1,5%_ Art 495 20 = 1,3% _ Art 495 26 = 1% _ Art 495 32 =1,4%.

Chemical and physical features

The inner layer degree of reticulation of the control test carried out on the samples accordingly to rule UNI EN 579 Art 495 16 = 66,4% _ Art 495 20 = 65,8% _ Art 495 26 = 65,7% _ Art 495 32 = 65,6%.

The outer layer degree of reticulation of the control test carried out on the samples accordingly to rule UNI EN 579 Art 495 16 =1,5%_ Art 495 20 = 1,3% _ Art 495 26 = 1% _ Art 495 32 =1,4%.

Secondo quanto previsto da UNI 10954 1 prospetto 5:

- 1) il materiale utilizzato per lo strato interno è PE-Xb mentre per lo strato esterno è HDPE
- 2) lo strato intermedio del tubo multistrato è in alluminio tipo A punto 5,3 norma UNI 10954 / 1
- 3) nessun scollamento si è verificato dopo la prova di Curvatura
- 4) gli strati non si sono separati dopo la prova di svasamento
- 5) l'aderenza degli strati di materiale plastico allo strato intermedio determinata mediante la separazione degli stessi ha dato il seguente esito:

Accordingly to what scheduled from UNI 10954 1 prospectus 5:

- 1) the material used for the internal layer is PE-Xb while the external layer is in HDPE
- 2) the intermediate layer of the multilayer tube is in aluminium, type A, point 5,3 rule UNI 10954 / 1
- 3) no breakaway has happened after the Bending test
- 4) the layers did not separate after the Countersinking Test
- 5) the bonding of the plastic material to the intermediate layer determined through the separation of the same, gave the following result:

N° prove - N° tests	Dimensioni - Dimension mm	Aderenza - Bonding N/cm
1	10.0	70.3
2	10.0	54.0
3	10.0	46.2
4	10.0	41.1
5	10.0	48.7
Media di 5 provini - Average of 5 tests	10.0	52.1

Il tubo multistrato Art 495 R, dove R sta per ricoperto, si differenzia dal tubo multistrato solo dalla copertura che viene ottenuta utilizzando polietilene espanso a cellule chiuse (tipo spugna). La pellicola che ricopre la spugna è fatta sempre in polietilene. La ricopertura segue la normativa L 10/91 secondo la normativa antincendio CL 1. La guaina è di colore osso cardinale mentre la spugna ha uno spessore di 6 mm equamente arrotolato intorno al tubo è di colore grigio. Sulla guaina sono riportate una serie di informazioni: data di confezionamento, misura del tubo, materia prima utilizzata, normative metratura per facilitarne l'utilizzo.

The multilayer tube Art. 495 R (R stands for covered) is different from the multilayer tube only for the cover obtained by using closed cells expanded polyethylene (sponge type). The tape covering the sponge is also made by polyethylene. The covering follows the regulation L 10/91 in accordance with the fire regulation CL 1. The cover is red colour while the sponge has a mm. 6 thickness equally wrapped around the tube and is grey colour. Some info are printed on the covering: packing date, tube length, raw material, measurement regulation to help the use.

SERIE 490 | 490 SERIE

Raccordi in ottone per tubo polietilene
Fittings for polyethylene pipe

Ogiva in metallo.
Metal ogive.



490 RM
Raccordo diritto maschio.
Straight male coupler.

Art.	Dimensione/Size	€
490 RM 12 20	1/2x20 mm	€ 4,20
490 RM 34 25	3/4x25 mm	€ 5,80
490 RM 10 32	1"x32 mm	€ 9,60
490 RM 114 40	1 1/4"x40 mm	€ 13,60
490 RM 112 50	1 1/2"x50 mm	€ 18,00
490 RM 20 63	2"x63 mm	€ 36,10



490 RF
Raccordo diritto femmina.
Straight female coupler.

Art.	Dimensione/Size	€
490 RF 12 20	1/2x20 mm	€ 4,30
490 RF 34 25	3/4x25 mm	€ 6,00
490 RF 10 32	1"x32 mm	€ 9,80
490 RF 114 40	1 1/4"x40 mm	€ 13,20
490 RF 112 50	1 1/2"x50 mm	€ 22,80
490 RF 20 63	2"x63 mm	€ 34,50



490 RD
Manicotto di accoppiamento.
Connecting coupler.

Art.	Dimensione/Size	€
490 RD 20 20	20x20 mm	€ 6,90
490 RD 25 25	25x25 mm	€ 9,30
490 RD 32 32	32x32 mm	€ 14,80
490 RD 40 40	40x40 mm	€ 27,00
490 RD 50 50	50x50 mm	€ 28,20
490 RD 63 63	63x63 mm	€ 56,00



490 GD
Raccordo a gomito bigiunto.
Connecting elbow.

Art.	Dimensione/Size	€
490 GD 20 20	20x20 mm	€ 6,10
490 GD 25 25	25x25 mm	€ 10,80
490 GD 32 32	32x32 mm	€ 15,80
490 GD 40 40	40x40 mm	€ 24,20
490 GD 50 50	50x50 mm	€ 48,40
490 GD 63 63	63x63 mm	€ 70,00



490 GF
Raccordo a gomito femmina.
Female elbow.

Art.	Dimensione/Size	€
490 GF 12 20	1/2x20 mm	€ 4,10
490 GF 34 25	3/4x25 mm	€ 8,20
490 GF 10 32	1"x32 mm	€ 12,00
490 GF 114 40	1 1/4"x40 mm	€ 18,60
490 GF 112 50	1 1/2"x50 mm	€ 27,40
490 GF 20 63	2"x63 mm	€ 52,10



490 GM
Raccordo a gomito maschio.
Male elbow.

Art.	Dimensione/Size	€
490 GM 12 20	1/2x20 mm	€ 4,60
490 GM 34 25	3/4x25 mm	€ 7,20
490 GM 10 32	1"x32 mm	€ 12,40
490 GM 114 40	1 1/4"x40 mm	€ 19,60
490 GM 112 50	1 1/2"x50 mm	€ 30,30
490 GM 20 63	2"x63 mm	€ 45,80



490 TE
Raccordo a "T".
Equal tee coupler.

Art.	Dimensione/Size	€
490 TE 20 20 20	20x20x20 mm	€ 9,20
490 TE 25 25 25	25x25x25 mm	€ 15,80
490 TE 32 32 32	32x32x32 mm	€ 22,90
490 TE 40 40 40	40x40x40 mm	€ 34,80
490 TE 50 50 50	50x50x50 mm	€ 62,20
490 TE 63 63 63	63x63x63 mm	€ 88,80



490 TF
Raccordo a "T" femmina.
Female tee coupler.

Art.	Dimensione/Size	€
490 TF 20 12 20	20x1/2x20 mm	€ 7,90
490 TF 25 34 25	25x3/4x25 mm	€ 9,60
490 TF 32 10 32	32x1"x32 mm	€ 17,60
490 TF 40 114 40	40x1 1/4"x40 mm	€ 30,40
490 TF 50 112 50	50x1 1/2"x50 mm	€ 37,00
490 TF 63 20 63	63x2"x63 mm	€ 62,20



490 TM
Raccordo a "T" maschio.
Male tee coupler.

Art.	Dimensione/Size	€
490 TM 20 12 20	20x1/2x20 mm	€ 7,10
490 TM 25 34 25	25x3/4x25 mm	€ 9,10
490 TM 32 10 32	32x1"x32 mm	€ 13,80
490 TM 40 114 40	40x1 1/4"x40 mm	€ 23,70
490 TM 50 112 50	50x1 1/2"x50 mm	€ 34,90
490 TM 63 20 63	63x2"x63 mm	€ 56,50

ACCESSORI PER RADIATORI - RADIATOR ACCESSORIES



540 DX
540 SX

Tappo zincato per radiatori in ghisa e acciaio, destro e sinistro, tappo cieco.
Zinc plated plug for radiators in cast iron and stainless steel, right and left, no hole plug.

	1"	1"x1/4	1"x3/8	1"x1/2	1"1/4	1"1/4x1/2
DX	€ 0,77	€ 0,77	€ 0,77	€ 0,92	€ 1,80	€ 2,00
SX	€ 0,77	€ 0,77	€ 0,77	€ 0,92	€ 1,80	€ 2,00



541 DX
541 SX

Tappo verniciato per radiatori in alluminio, destro e sinistro, tappo cieco.
Plug for radiators in aluminium, painted white, right and left, no hole plug.

	1"	1"x1/4	1"x3/8	1"x1/2	1"x3/4	1"1/4
DX	€ 0,89	€ 0,89	€ 0,89	€ 1,70	€ 1,20	€ 2,00
SX	€ 0,89	€ 0,89	€ 0,89	€ 1,70	€ 1,20	€ 2,00



430

Valvolina sfogo aria manuale, per radiatori, con guarnizione in P.T.F.E. cromata.
C.P. drain plug for radiators with P.T.F.E. seal ring.

1/4	3/8	1/2
€ 0,87	€ 1,30	€ 1,42



431

Valvolina sfogo aria manuale, per radiatori, cromata a scarico orientabile.
C.P. drain plug for radiators, adjustable.

3/8	1/2
€ 0,87	€ 0,92



431 TA

Tappo in ottone cromato per radiatori.
C.P. brass plug for radiators.

3/8	1/2
€ 0,76	€ 0,83



544

Chiave in plastica dura, per tappi verniciati.
Key for art. 541, in strong plastic.

€ 5,10



545

1/2 - 3/8 € 6,70

Kit per radiatori in alluminio, composto da: 2 riduzioni destre e 2 sinistre, tutte verniciate, da 1"x 3/8 o 1"x 1/2, 1 tappo cieco in ottone con o-ring da 3/8 o 1/2, 4 guarnizioni esente amianto, spessore 1,5 mm e Ø 42 mm, 1 valvola di sfogo aria da 3/8 o 1/2, il tutto in skinpack Remer.

Kit for aluminum radiators, composed by: 2 right and 2 left reductions, all painted, size 1"x3/8 or 1"x1/2, 1 no hole plug in brass with 3/8 or 1/2 oring, 4 asbestos free washers thickness 1,5 mm and Ø 42 mm, 1 drain plug in 3/8 or 1/2 size, all packed in a Remer skinpack.



546

1/2 - 3/8 € 6,50

Kit per radiatori in ghisa, composto da: 2 riduzioni destre e 2 sinistre, zincate, disponibili da: 1"x 3/8, 1"x 1/2, 1"1/4x 3/8, 1"1/4x1/2, 1 tappo cieco in ottone con o-ring da 3/8 o 1/2, 4 guarnizioni esente amianto, spessore 1,5 mm e Ø 42, 1 valvola di sfogo aria da 3/8 o 1/2, il tutto in skinpack Remer.

Kit for iron radiators, composed by: 2 right and 2 left reductions, all painted, available is sizes: 1"x3/8, 1"x1/2, 1"1/4x3/8, 1"1/4x1/2, 1 no hole plug in brass with 3/8 or 1/2 oring, 4 asbestos free washers thickness 1,5 mm and Ø 42 mm, 1 drain plug in 3/8 or 1/2 size, all packed in a Remer skinpack.



548

1/2 - 3/8 € 9,40

Kit per radiatori in alluminio, composto da: 2 riduzioni destre e 2 sinistre, tutte verniciate, da 1"x 3/8 o 1"x 1/2, 1 tappo cieco in ottone con o-ring da 3/8 o 1/2, 4 guarnizioni esente amianto, spessore 1,5 mm e Ø 42, 1 valvola di sfogo aria da 3/8 o 1/2, coppia mensole piatte complete con tassello Ø mm 12, lunghezza mm 170, il tutto in skinpack Remer.

Kit for aluminum radiators, composed by: 2 right and 2 left reductions, all painted, size 1"x3/8 or 1"x1/2, 1 no hole plug in brass with 3/8 or 1/2 oring, 4 asbestos free washers thickness 1,5 mm and Ø 42 mm, 1 drain plug in 3/8 or 1/2 size, two painted and flat anchor brackets, with nut Ø mm 12, length mm 170, all packed in a Remer skinpack.

MINUTERIA
MINUTERY

VALVOLE
VALVES

RACCORDERIA
FITTINGS

ACCESSORI
ACCESSORIES

COMPONENTI PLASTICI
PLASTIC COMPONENTS



621

Collare fermatubo con tassello, in nylon, con vite in ferro zincato, conf 100 pz.
Collars for pipes clamping with nylon nut and zinc iron screws, in packing of 100 pcs.

Ø	10 mm	12 mm	14 mm	16 mm	18 mm	20 mm	22 mm	24 mm	26 mm	28 mm
€	0,19	0,20	0,30	0,32	0,50	0,52	0,58	0,82	0,86	0,88



622

Collare doppio fermatubo con tassello, in nylon, con vite in ferro zincato, conf. 100 pz.
Double collars for pipes clamping with nylon nut and zinc iron screws, in packing of 100 pcs.

Ø	10 mm	12 mm	14 mm	16 mm	18 mm	20 mm	22 mm	24 mm	26 mm	28 mm
€	0,44	0,46	0,48	0,52	0,70	0,74	0,76	0,98	0,98	1,10



630

€ 3,20

Coppia mensole Ø 12 per radiatori in ghisa e acciaio a 4/5 colonne, con tasselli, lunghezza mm 205.
Two galvanized anchor brackets Ø 12 for holding radiators in iron and steel with 4/5 columns, with nuts, length mm 205.



632

€ 2,00

Coppia mensole zincate Ø 7, per radiatori in alluminio, con tasselli, lunghezza mm 170.
Two galvanized anchor brackets Ø 7 for holding radiators in aluminium, with nuts, length mm 170

630 BI

€ 3,80

Coppia mensole verniciate bianche Ø 12 per radiatori in ghisa e acciaio a 4/5 colonne, con tasselli, lunghezza mm 205.
Two galvanized anchor brackets painted white Ø 12 for holding radiators in iron and steel with 4/5 columns, with nuts, length mm 205.

632 BI

€ 1,80

Coppia mensole bianche verniciate Ø 7, per radiatori in alluminio, con tasselli, lunghezza mm 170.
Two galvanized anchor brackets Ø 7 painted white for holding radiators in aluminium, with nuts, length mm 170.

632 PL

€ 1,90

Coppia mensole bianche plastificate Ø 7 per radiatori in alluminio, con tasselli, lunghezza mm 170.
Two galvanized anchor brackets Ø 7 white and plastified for holding radiators in aluminium, with nuts, length mm 170.



633

€ 2,00

Coppia mensole Ø 7 bianche verniciate e di forma piatta, per radiatori in alluminio, con tasselli, lunghezza mm 170.
Two galvanized anchor brackets Ø 7 flat shaped and painted white for holding radiators in aluminium, with nuts, length mm 170.

633 PL

€ 2,00

Coppia mensole Ø 7 bianche plastificate, verniciate e di forma piatta, per radiatori in alluminio, con tasselli, lunghezza mm 170.
Two galvanized anchor brackets Ø 7 plastified, flat shaped and painted white for holding radiators in aluminium, with nuts, length mm 170.



635

Ø mm 220 € 0,76

Ø mm 260 € 0,85

Mensola zincata per radiatori in ghisa e acciaio spessore 15/10, lunghezza mm 220 e 260.
Wall bracket for holding radiators in iron and steel, thickness 15/10, length mm 220 e 260.

ACCESSORI PER TUBI - ACCESSORIES FOR PIPES



642

Collari pesanti zincati con dado saldato e tassello, per tubazioni.
Wall collars in galvanized steel welded and plastic nut, for pipes.

3/8	1/2	3/4	1"	1 1/4	1 1/2	2"	2 1/2	3"	4"
€ 0,58	€ 0,66	€ 0,68	€ 0,80	€ 0,85	€ 0,87	€ 0,98	€ 1,06	€ 1,32	€ 1,63



643

Collari pesanti in acciaio zincato con dado saldato, con gomma EPDM isolante e tassello, per tubazioni.

Wall collars in galvanized steel welded, with insulating EPDM rubber, with plastic nut, for pipes.

3/8	1/2	3/4	1"	1 1/4	1 1/2	2"	2 1/2	3"	4"
€ 0,82	€ 0,98	€ 1,02	€ 1,12	€ 1,18	€ 1,30	€ 1,62	€ 2,05	€ 2,30	€ 2,60



640

Sgombratubi in filo d'acciaio a spirale Ø mm. 8.
Drain cleaner in 8 mm Ø stainless steel spiral.

	LUNGHEZZA - LENGHT								
Ø 8 mm	150 cm	250 cm	350 cm	500 cm	700 cm	1000 cm	1250 cm	1500 cm	
	€ 3,40	€ 5,00	€ 6,10	€ 8,40	€ 11,10	€ 15,30	€ 16,70	€ 21,40	



645

Fascetta stringitubo in acciaio.
Steel hose clip.

Ø	10/18	14/24	17/29	25/37	25/45	33/53	40/60	48/68	63/83	78/98
	€ 0,69	€ 0,69	€ 0,71	€ 0,82	€ 0,82	€ 0,87	€ 0,90	€ 0,92	€ 0,95	€ 1,10

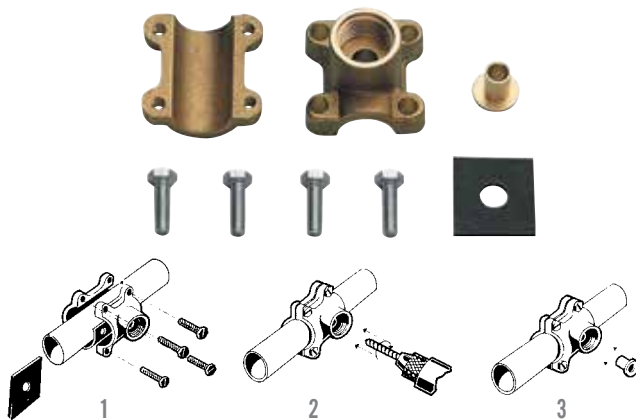

644

Presca rapida per tubi, misure da 1/2" a 2".
Fast punch for water outlet, size from 1/2" to 2".

	Ø A	Ø B	G"
Tubo Pipe	Foro per Acqua Water Hole	Diametro Punta Drill Diameter	Filetto Thread
1/2	7,5 mm	Ø 10 mm	1/2
3/4	10,5 mm	Ø 13,5 mm	1/2
1"	13 mm	Ø 16 mm	3/4
1 1/4	14 mm	Ø 17,5 mm	3/4
1 1/2	14 mm	Ø 17,5 mm	3/4
2"	30 mm	Ø 35 mm	1 1/2

1/2x45	3/4x45	1"x45	1 1/4x71	1 1/2x77	2"x90
€ 7,60	€ 9,80	€ 17,30	€ 19,70	€ 21,80	€ 38,70

MINUTERIA
MINUTERY

VALVOLE
VALVES

RACCORDERIA
FITTINGS

ACCESSORI
ACCESSORIES

COMPONENTI PLASTICI
PLASTIC COMPONENTS



ACCESSORI ACCESSORIES



MINUTERIA
MINUTERY

VALVOLE
VALVES

RACCORDERIA
FITTINGS

ACCESSORI
ACCESSORIES

COMPONENTI PLASTICI
PLASTIC COMPONENTS



RUBINETTI - MIXERS

61  € 30,30
 Rubinetto prolungato con comando a gomito, 1/2.
 Wall mounted long tap, 1/2, with long lever.

63  € 33,70
 Rubinetto a snodo con comando a gomito, 1/2, con canna inferiore.
 Wall mounted hose-holder tap, 1/2, with long lever and S inferior spout.

64  € 63,60
 Gruppo lavello con comando a gomito e canna inferiore.
 Wall mounted mixer, with long levers and S inferior spout.

14 LL  € 75,30
 Gruppo lavello tipo a ponte con comando a gomito e canna Ø 18 mm.
 Sink mixer bridge type, with long lever and spout Ø 18 mm.

65  € 39,40
 Rubinetto collo cigno con comando a gomito, 1/2.
 Wash basin pillar tap, 1/2, with long lever.

61 LE  € 10,60
 Leva in ottone cromato per articoli 61, 63, 64, 65, 14LL.
 Lever for art. 61, 63, 64, 65, 14LL.

MA 14  € 22,00
 Leva lunga per miscelatori con cartuccia Ø 40.
 Spare long lever for single lever mixers with Ø 40 cartridge.

61 VI  € 5,00
 Vitone da 1/2 per articoli 61, 63, 64, 65, 14LL.
 Head valve 1/2 for articles 61, 63, 64, 65, 14LL.

66  € 120,40
 Rubinetto a pedale ad incasso in ottone cromato.
 Built in tap foot operated, in c.p. brass.

66 MP  € 128,20
 Rubinetto-miscelatore pedaliera universale. Può essere installato sia a parete che a pavimento.
 Treadle mixer with universal pedal control. It can be installed both on the wall and on the floor.

67  € 43,30
 Bocca a snodo per lavello.
 Movable spout for washbasin.

67 N  € 62,20
 Bocca alta minimale.
 Minimal high spout.

67 Q  € 90,70
 Bocca alta quadrata.
 Squared high spout.

69  € 56,40
 Rubinetto a pulsante a zampillo parabolico per refrigeratore o depuratore. Regolazione del getto sotto il pulsante.
 Parabolic jet button tap for refrigerator or purifier. Water flow control under the button.

CARTUCCE - CARTRIDGES

P 50  € 23,40
 Cartuccia progressiva Ø 35, con distributori, con chiusura del flusso e uscita dell'acqua verso il basso.
 Ceramic cartridge Ø 35, with distributors, with flow shut-off and water outlet towards the low.

P 52  € 23,40
 Cartuccia progressiva Ø 35, senza distributori, con chiusura del flusso e uscita dell'acqua verso il basso.
 Ceramic cartridge Ø 35, without distributors, with flow shut-off and water outlet towards the low.

V 50 C  € 21,40
 Cartuccia a dischi ceramici Ø 25 mm, tipo piatto.
 Ceramic cartridge Ø 25 mm, flat bottom type

V 50 A  € 21,40
 Cartuccia a dischi ceramici Ø 25, con uscita dell'acqua direttamente dalla parte alta dell'involucro a cilindro senza quindi essere riconvolgato verso il fondo della cartuccia.
 Ceramic discs cartridge Ø 25, with water outlet directly from the top part of the cylindrical shell without being joined towards the bottom of the cartridge.



J 50
 Cartuccia a dischi ceramici Ø mm 35, movimento a "joystick", tipo piatto.
 Ceramic cartridge Ø 35 mm, "joystick" movement, flat bottom type

€ 19,50



E 50 C
 Cartuccia termostatica coassiale serie MINIMAL THERMO e QUBIKA THERMO.
 Thermostatic coaxial cartridge serie MINIMAL THERMO and QUBIKA THERMO.

€ 88,10



NEW

E 50 P
 Cartuccia termostatica con rotazione manopola a 330° angolari, blocco di sicurezza a 38°C, campo di lavoro da 5°C a 80°C, campo di pressione da 1 a 10 bar, filtro inox e sistema di sicurezza con blocco dell'erogazione in caso di mancanza di una delle due acque, realizzato con materiali termoplastici ad elevata robustezza.
 Thermostatic cartridge with 330° angular handle rotation, 38° safety lock, working field from 5°C to 80°C, pressure field from 1 to 10 bar, stainless steel filter and safety system with the outlet lock in case there is one water lock, high performance thermoplastic materials.

€ 38,70



E 50
 Cartuccia termostatica con rotazione manopola a 330° angolari, blocco di sicurezza a 38°C, campo di lavoro da 5°C a 80°C, campo di pressione da 1 a 10 bar, filtro inox e sistema di sicurezza con blocco dell'erogazione in caso di mancanza di una delle due acque.
 Thermostatic cartridge with 330° angular handle rotation, 38° safety lock, working field from 5°C to 80°C, pressure field from 1 to 10 bar, stainless steel filter and safety system with the outlet lock in case there is one water lock.

€ 48,70

MINUTERIA
MINUTERY

VALVOLE
VALVES

RACCORDERIA
FITTINGS

ACCESSORI
ACCESSORIES

COMPONENTI PLASTICI
PLASTIC COMPONENTS

CARTUCCE IN BLISTER CARTRIDGES IN BLISTER



S 50
 Cartuccia Ø mm 40 a dischi in ceramica per vasca, lavabo, bidet (tipo con distributori).
 Ceramic cartridge Ø 40 mm for bath, wash basin, bidet (type with distributor).

€ 9,40



S 52
 Cartuccia Ø mm 40 a dischi in ceramica per lavello, doccia (tipo piatto).
 Ceramic cartridge Ø 40 mm for sink and shower (flat bottom type).

€ 9,40



R 50
 Cartuccia Ø mm 35 a dischi in ceramica per vasca, lavabo, bidet (tipo con distributori).
 Ceramic cartridge Ø 35 mm for bath, wash basin, bidet (type with distributor).

€ 9,40



R 52
 Cartuccia Ø mm 35 a dischi in ceramica per lavello, doccia (tipo piatto).
 Ceramic cartridge Ø 35 mm for sink and shower (flat bottom type).

€ 9,40



CLICK SYSTEM

S 50 AF
 Cartuccia ad apertura forzata Ø mm 40 a dischi ceramici per vasca, lavabo, bidet (tipo con distributori) permette un notevole risparmio idrico.
 Forced opening ceramic cartridge Ø 40 mm for bath, wash basin, bidet (type with distributors) permit a remarkable saving of water.

€ 11,40



CLICK SYSTEM

S 52 AF
 Cartuccia ad apertura forzata Ø mm 40 a dischi ceramici per lavello, doccia (tipo piatto) permette un notevole risparmio idrico.
 Forced opening ceramic cartridge Ø 40 mm for sink, shower (flat bottom type) permit a remarkable saving of water.

€ 11,40



CLICK SYSTEM

R 50 AF
 Cartuccia ad apertura forzata Ø 35 mm a dischi ceramici per vasca, lavabo, bidet (tipo con distributori) permette un notevole risparmio idrico.
 Forced opening ceramic cartridge Ø 35 mm for bath, wash basin, bidet (type with distributors) permit a remarkable saving of water.

€ 11,40



CLICK SYSTEM

R 52 AF
 Cartuccia ad apertura forzata Ø 35 mm a dischi ceramici per lavello, doccia (tipo piatto) permette un notevole risparmio idrico.
 Forced opening ceramic cartridge Ø 35 mm for sink, shower (flat bottom type) permit a remarkable saving of water.

€ 11,40



NEW

W 50
 Cartuccia Ø mm 35 a dischi ceramica per lavello, doccia, vasca, bidet (tipo piatto).
 Ceramic cartridge Ø 35 mm for sink, shower, bath, bidet (flat bottom type).

€ 19,50

DEVIATORI - DIVERTERS



Q 34 DEV 5

CR € 247,60

Deviatore a 5 posizioni per doccia (1 via in entrata e 5 vie in uscita) su piastra, serie Qubika.
Shower 5 outlet way diverter (1 inlet way and 5 outlet ways) on flange, for Qubika serie.



Q 93 DEV 3

CR € 231,80

Deviatore a tre vie (una entrata e tre uscite) su piastra, serie Qubika.
Three ways diverter (1 inlet and 3 outlets) on flange, Qubika serie.



Q 93 DEV 7

CR € 231,80

Deviatore a tre vie e sette posizioni (una entrata, tre uscite e sette posizioni con cui selezionare uscite singole o miscelate tra loro) su piastra, serie Qubika.
Three ways diverter with seven positions (1 inlet and 3 outlets and seven positions to select single or mixed outlets) on flange, Qubika serie.



N 34 DEV 5

CR € 229,80

Deviatore a 5 posizioni per doccia (1 via in entrata e 5 vie in uscita) su piastra, serie Minimal.
Shower 5 outlet way diverter (1 inlet way and 5 outlet ways) on flange, for Minimal serie.



N 93 DEV 3

CR € 203,00

Deviatore a tre vie (una entrata e tre uscite) su piastra, serie Minimal.
Three ways diverter (1 inlet and 3 outlets) on flange, Minimal serie.



N 93 DEV 7

CR € 203,00

Deviatore a tre vie e sette posizioni (una entrata, tre uscite e sette posizioni con cui selezionare uscite singole o miscelate tra loro) su piastra, serie Minimal.
Three ways diverter with seven positions (1 inlet and 3 outlets and seven positions to select single or mixed outlets) on flange, Minimal serie.

PROLUNGHE - EXTENSIONS



K 09 PROL

€ 60,00

Prolunga per corpo monocomando doccia incasso con deviatore per cartuccia Ø 40 mm.
Extension for built-in shower mixer body with diverter for cartridge Ø 40 mm.



N 09 PROL

€ 60,00

Prolunga per corpo monocomando doccia incasso con deviatore per cartuccia Ø 35 mm.
Extension for built-in shower mixer body with diverter for cartridge Ø 35 mm.



S 52 PROL

€ 25,60

Prolunga per corpo monocomando doccia incasso con cartuccia Ø 40 mm.
Extension for built-in shower mixer body with cartridge Ø 40 mm.



R 52 PROL

€ 25,60

Prolunga per corpo monocomando doccia incasso con cartuccia Ø 35 mm.
Extension for built-in shower mixer body with cartridge Ø 40 mm.

DEVIATORI AUTOMATICI - AUTOMATIC DIVERTERS



78

€ 0,15

Vite fissa maniglia.
Screw for fixing handle.



80 SN

€ 0,99

Morsetto con vite per scarico automatico.
Joint with screw for pop-up waste.



DEV 00

€ 8,60

Deviatore in ottone automatico con molla e fermo per basse pressioni.
Automatic brass diverter with spring and lock for low pressure.



DEV 08

€ 10,50

Deviatore in ottone automatico con molla e fermo, con prolunga 8 mm.
Automatic brass diverter with spring and lock, mm 8 extended in 1/2 side.



DEV 13

€ 12,10

Deviatore in ottone automatico con molla e fermo, con prolunga 13 mm.
Automatic brass diverter with spring and lock, mm 13 extended in 1/2 side.

VITONI - HEADVALVES



75 € 21,10
 Vitone universale per rubinetti, che permette di ottenere 102 combinazioni di misure e lunghezze. Confezione skin-pack.
 Universal headvalve for taps, allow to create 102 different combinations of lengths and sizes. Packed in a safe skin-pack.



77 19 € 4,20
 Vitone con filetto 19/19, per rubinetti incasso.
 19/19 Head valve thread, for built-in stop cocks.



74 € 3,40
 Vitone da 1/2 per gruppo vasca, lavello, batteria lavabo, rubinetto bidet e incasso per art. 53, 55.
 Head valve 1/2" for bath, sink, wash basin, bidet and built-in stop cock for art. 53, 55.



74 E € 2,60
 Come 74, tipo leggero.
 As 74, light type.



74 F € 3,60
 Vitone da 1/2 con filetto per coprivitone M24x1.
 Head valve 1/2 with thread M24x1 for head valve cover.



77 18 € 2,60
 Vitone filetto 18/19 per art. 221, 223, 224, 250, 252 e altri.
 18/19 Head valve thread for art. 221, 223, 224, 250, 252 and others.



77 38 € 2,60
 Vitone con filetto 3/8, per rubinetti.
 3/8 Head valve thread, for taps.



76 DX 180 € 7,60
 Vitone 180° a dischi ceramici, broccia Ø mm 8, 20 denti, destro.
 Head valve 180° ceramic discs, broach Ø 8 mm, 20 teeth, right.



76 DX 24 € 7,60
 Vitone 90° a dischi ceramici, broccia Ø 8 mm, 24 denti, destro.
 Head valve 90° ceramic discs, broach Ø 8 mm, 24 teeth, right.



76 DX € 7,60
 Vitone 90° a dischi ceramici, broccia Ø 8 mm, 20 denti, destro.
 Head valve 90° ceramic discs, broach Ø 8 mm, 20 teeth, right.



76 SX 180 € 7,60
 Vitone 180° a dischi ceramici, broccia Ø mm 8, 20 denti, sinistro.
 Head valve 180° ceramic discs, broach Ø 8 mm, 20 teeth, left.



76 SX 24 € 7,60
 Vitone 90° a dischi ceramici, broccia Ø 8 mm, 24 denti, sinistro.
 Head valve 90° ceramic discs, broach Ø 8 mm, 24 teeth, left.



76 SX € 7,60
 Vitone 90° a dischi ceramici, broccia Ø 8 mm, 20 denti, sinistro.
 Head valve 90° ceramic discs, broach Ø 8 mm, 20 teeth, left.

MINUTERIA
MINUTERY

VALVOLE
VALVES

RACCORDERIA
FITTINGS

ACCESSORI
ACCESSORIES

COMPONENTI PLASTICI
PLASTIC COMPONENTS



AERATORI: LINEA RISPARMIO IDRICO-ENERGICO E ANTIVANDALICO
AERATOR: WATER ENERGY SAVING LINE AND ANTI-VANDALISM



83 AVC € 4,00

Kit antivandalico e anticalcare composto da aeratore speciale per miscelatori lavabo e bidet M24 e chiave di montaggio, manutenzione e pulizia settimanale, ad alta tecnologia, brevettata. Anti-vandalism and anti-limestone kit, composed by special aerator for wash basin and bidet mixers M24 and assembly, caring and weekly cleaning key, high technology and patented.



83 SET L6 - 83 SET L8

Set risparmio idrico totale composto da raccordo doccia 1/2" in ottone cromato a portata limitata, aeratore lavabo e bidet M24 a portata limitata e chiave di montaggio manutenzione e pulizia settimanale, ad alta tecnologia, brevettata. Il kit e' disponibile in varianti da 6 litri al minuto (cod 83 SET L6) o 8 litri al minuto (cod 83 SET L8).

Total water saving set, composed by 1/2" shower connection with reduced flow in c.p. brass, wash basin and bidet aerator with reduced flow and assembling, caring and weekly cleaning key, high technology, patented. This set is available with outlet flow of 6 liters by minute (cod 83 SET L6) or 8 liters by minute (cod 83 SET L8).



83 AVC L6 - 83 AVC L8

Kit come 83 AVC, più risparmio idrico, che include anche limitatore di portata da 6 litri al minuto, art 83AVC L6, o limitatore di portata da 8 litri al minuto, art 83 AVC L8.

Kit same as 83 AVC, plus water saving, that also includes one reduction of water consumption at 6 liters by minute, art 83 AVC L6, or one reduction of water consumption at 8 liters by minute, art 83 AVC L8.

83 AVC L6
€ 5,80

83 AVC L8
€ 5,80



83 L6 - 83 L8

Aeratore lavabo e bidet M24, per risparmio idrico con limitatore di portata da 6 litri al minuto (art. 83 L6) o da 8 litri al minuto (art. 83 L8).

Aerator for wash basin and bidet mixers, M24, water saving, with reduction of consumption and excellent flow at 6 litres by minute (art. 83 L6) or 8 liters by minute (art. 83 L8).

83 L6
€ 3,30

83 L8
€ 3,30

83 SET L6
€ 11,70

83 SET L8
€ 11,70



662 FI 12

Guarnizione da 1/2" con filtro retinato anti-impurità. 1/2" washer with net filter, anti-impurity.

€ 0,29



662 RE 12

Guarnizione da 1/2" a passaggio ridotto, con risparmio idrico del 30%. 1/2" washer, reduced flow, water saving 30%.

€ 0,22



309R L6 - 309R L8

Raccordo doccia 1/2" a risparmio idrico con limitatore di portata da 6 litri al minuto (art 309 L6) o 8 litri al minuto (art 309 L8).

C.p. brass connection, water saving program with flow reduction at 6 liters by minute (art 309 L6) or 8 liters by minute (art 309 L8).

309R L6
€ 4,60

309R L8
€ 4,60



KIT PULIZIA AERATORE
CLEANING KIT WITH AERATOR



83 SET 01

€ 8,20

Set completo di 3 aeratori anticalcare M24 ad alta tecnologia + 1 chiave per la pulizia settimanale, brevettati e di lunghissima durata, il tutto in ottone cromato e materiale plastico innovativo a forte resistenza, confezionato in un tubo contenitore rigido e trasparente adatto per essere appeso. La chiave è stata studiata per pulire il calcare dall'aeratore in un solo semplice movimento.

Set complete of 3 anti-limestone M24 aerators of high technology + 1 weekly cleaning key, patented and extremely long lasting, all in c.p. brass and innovative plastic material very resistant, packed in a holding hard and transparent tube, suitable to be hung. The key has been studied to clean the aerator in one simple, easy movement.



83 SET 02

€ 8,20

Set completo di 2 aeratori anticalcare M24 ad alta tecnologia ed e 1 aeratore anticalcare F22 + 1 chiave per la pulizia settimanale, brevettati e di lunghissima durata, il tutto in ottone cromato e materiale plastico innovativo a forte resistenza, confezionato in un tubo contenitore rigido e trasparente adatto per essere appeso. La chiave è stata studiata per pulire il calcare dall'aeratore in un solo semplice movimento.

Set complete of 2 anti-limestone M24 aerators of high technology and 1 anti-limestone F22 aerator + 1 weekly cleaning key, patented and extremely long lasting, all in c.p. brass and innovative plastic material very resistant, packed in a holding hard and transparent tube, suitable to be hung. The key has been studied to clean the aerator in one simple, easy movement.

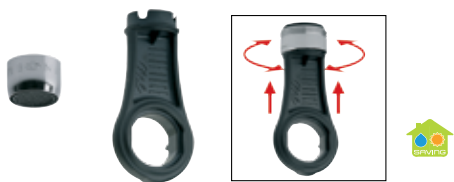

81 AC € 2,90

Set completo di 1 aeratore F22 anticalcare ad alta tecnologia + 1 chiave di pulizia settimanale, brevettati e di lunghissima durata, il tutto in ottone cromato e materiale plastico innovativo a forte resistenza. L'aeratore e la chiave sono stati studiati per pulire il calcare dall'aeratore in un solo semplice movimento.
Set complete of 1 anti-limestone F22 aerator of high technology + 1 weekly cleaning key, Patented and extremely long lasting, all in c.p. brass and innovative plastic material very resistant. The aerator and the key has been studied to clean the aerator in one simple, easy movement.



83 AC € 2,90

Set completo di 1 aeratore M24 anticalcare ad alta tecnologia + 1 chiave di pulizia settimanale, brevettati e di lunghissima durata, il tutto in ottone cromato e materiale plastico innovativo a forte resistenza. L'aeratore e la chiave sono stati studiati per pulire il calcare dall'aeratore in un solo semplice movimento.
Set complete of 1 anti-limestone M24 aerator of high technology + 1 weekly cleaning key, Patented and extremely long lasting, all in c.p. brass and innovative plastic material very resistant. The aerator and the key has been studied to clean the aerator in one simple, easy movement.



RIDUZIONI - REDUCTION



81 RD 12 € 4,40

Riduzione 1/2MxM22. Consente di collegare qualsiasi attacco da 1/2F", esempio tutti i flessibili doccia, con un aeratore standard lavabo/lavello F22, vedi ns articolo 81A (al posto di una doccetta o di uno shut off).
Reduction 1/2MxM22. Allows to connect any 1/2F" connection, for example all the shower flexibles, with a standard aerator basin/sink F22, see our art. 81A (instead of the classic handshower or shut-off).



81 RD 12M 22F € 4,40

Riduzione 1/2MxF22. Consente di collegare al lavabo/lavello F22 un qualsiasi componente con attacco 1/2F.
1/2MxF22 reduction. Connecting any component with 1/2F connection to the washbasin/sink F22.



83RD 12F 22F € 4,40

Riduzione 1/2FxM22. Consente di collegare al lavabo/lavello F22 un qualsiasi componente con attacco 1/2M.
1/2FxM22 reduction. Connecting any component with 1/2M connection to the washbasin/sink F22.



83 RD 12 € 4,40

Riduzione 1/2MxF24. Consente di collegare qualsiasi attacco da 1/2F", esempio tutti i flessibili doccia, con un aeratore standard lavabo M24, vedi ns articolo 83A (al posto di una doccetta o di uno shut off).
Reduction 1/2MxF24. Allows to connect any 1/2F" connection, for example all the shower flexibles, with a standard aerator basin M24, see our art. 83A (instead of the classic handshower or shut-off).



83 RD 12M 24M € 4,40

Riduzione 1/2MxM24. Consente di collegare al lavabo/lavello M24 un qualsiasi componente con attacco 1/2F.
1/2MxM24 reduction. Connecting any component with 1/2F connection to the washbasin/sink M24.



83RD 12F 24M € 4,40

Riduzione 1/2FxM24. Consente di collegare al lavabo/lavello M24 un qualsiasi componente con attacco 1/2M.
1/2FxM24 reduction. Connecting any component with 1/2M connection to the washbasin/sink M24.



82 € 2,20

Aeroflux a due getti, con doccetta a snodo, filetto F22 con riduzione M24.
Double spray aerator, with balljoint shower, thread F22 with reduction M24.



82 DJ € 42,00

Aeroflux "Dual Jet" in ottone cromato a due getti, con doccetta a snodo e filetto F22.
Double spray c.p. brass shower-aerator "Dual Jet", with ball-joint shower, thread F22.



82 UN € 1,50

Aeroflux a due getti, con doccetta a snodo, con attacco universale.
Double spray aerator, with balljoint shower, with standard connection.



82 L € 1,80

Aeroflux a due getti, con manicotto a vite, lunghezza cm 15.
Double spray aerator, with screw standard connection, length 15 cm.



82 LGH € 2,30

Aeroflux a due getti, con ghiera e filetto F22, lunghezza 15 cm.
Double spray aerator, with nut and thread F22, length 15 cm.

MINUTERIA
MINUTERY

VALVOLE
VALVES

RACCORDERIA
FITTINGS

ACCESSORI
ACCESSORIES

COMPONENTI PLASTICI
PLASTIC COMPONENTS

AERATORI - AERATOR

81 A



€ 1,50

Aeratore anticalcare ad alta tecnologia F22, brevettato e di lunghissima durata, scocca in ottone ed interno in materiale plastico innovativo a forte resistenza.
High technology anti-limestone aerator F22, patented and long-lasting, shell in c.p. brass, internal in innovative plastic material very resistant.

83 A



€ 1,50

Aeratore anticalcare ad alta tecnologia M24, brevettato e di lunghissima durata, scocca in ottone ed interno in materiale plastico innovativo a forte resistenza.
High technology anti-limestone aerator M24, patented and long-lasting, shell in c.p. brass, internal in innovative plastic material very resistant.

83 C



€ 1,80

Chiave brevettata per la pulizia settimanale degli aeratori ad alta tecnologia art 81 A e art 83 A.
Patented key for the weekly cleaning of the high technology aerators art 81 A and 83 A.

81



€ 1,50

Aeratore classico con retine in inox, per gruppo lavello F22.
Classic aerator with inox nets, for sink spout F22.

83



€ 1,50

Aeratore classico con retine in inox, per lavabo, lavello e bidet M24.
Classic aerator with inox nets, for basin, bidet and sink, M24.

84



€ 2,20

Aeratore per gruppo vasca, M28.
Aerator for bath mixer, M28.

83 F16 € 3,80



Aeratore F16.
F16 aerator.

81 SN

€ 2,70

Snodo attacco F22 con ghiera M22.
Joint F22 and nut M22.

83 SN

€ 2,70

Snodo attacco M22 con ghiera M24.
Joint M22 and nut M24.

83 N41 € 3,20



Aeratore M18.
M18 aerator.

85



€ 4,20

Aeratore con snodo per monoforo bidet, M24.
Balljoint aerator for one-hole bidet, M24.

83 NE SI

€ 3,40

Aeratore Neoperl autopulente M24X1 con erogatore in silicone morbido anticalcare per una pulizia manuale semplificata.
Neoperl aerator selfcleaning M24X1 with silicon antilimestone bottom, for soft simplified handcleaning.

83 NE

€ 1,80

Aeratore Neoperl effetto a scomparsa, con tecnologia in silicone autopulente per una pulizia veloce dal calcare, con filetto M24X1 che puo' essere sostituito senza difficoltà a tutte le rubinetterie con filettatura per aeratore M24X1. Molto indicato per modelli di design quali Qubika, Minimal, SQ.
Neoperl aerator with built-in effect, with silicon anti-limestone technology for an easier cleaning, M24X1 thread, can be easily substituted to all the standard mixers with M24X1 aerators.
Very indicated for design models like Qubika, Minimal, SQ.

83 NE BA

€ 3,60

Aeratore Neoperl M24X1 con getto direzionabile tramite terminale basculante, permette con il semplice tocco della parte inferiore dell'aeratore di dirigere il flusso della direzione desiderata.
Neoperl aerator M24X1 with movable aerator bottom that, with the simple touch, permits to move the flow to the preferred direction.

83 EU

€ 1,60

Aeratore Neoperl M24 coin slot. Installazione e rimozione dell'aeratore utilizzando una moneta inserita nell'apposita fessura.
Neoperl aerator M24 coin slot. Installation and removal of the aerator by using a coin placed in the slot.

83 Z40

€ 3,90

Aeratore M24 ultrapiatto, utilizzabile su ogni lavabo o lavello. Installazione e rimozione con chiave 83 Z40 C.
Ultra-flat aerator M24, suitable on every wash-basin or sink. Installation and removal with key 83 Z40 C.

83 Z40 C

€ 1,80

Chiave brevettata per la pulizia settimanale degli aeratori ad alta tecnologia art 83 Z40.
Patented key for the weekly cleaning of the high technology aerators art 83 Z40.

ECCENTRICI E DISTANZIATORI - ECCENTRICS & CONNECTIONS

89  € 2,50
Eccentrico per gruppi, 1/2 x 3/4, con rosone in ottone cromato.
Eccentric unions for mixers, 1/2 x 3/4, with C.P. brass flange.

89 L  € 3,00
Eccentrico per gruppi, 1/2x3/4, tipo Lusso, con rosone in ottone cromato.
Eccentric unions for mixers, 1/2 x 3/4, with C.P. brass flange.

89 N  € 4,50
Eccentrico per gruppi, 1/2 x 3/4, con rosone minimale in ottone cromato.
Eccentric unions for mixers, 1/2 x 3/4, with minimal C.P. brass flange.

90 
Distanziatore per gruppi, 1/2x3/4, lunghezza cm.4, 6, 8.
C.P. brass S-connection for mixers, 1/2x3/4, length 4, 6, 8 cm.
cm 4 € 12,30 **cm 6** € 13,10 **cm 8** € 14,00

MINUTERIA
MINUTERY

VALVOLE
VALVES

COLONNE PER BORDO VASCA - VERTICAL CONNECTION FOR BATH MIXER

88 01 LI  CR € 312,10
Coppia colonnette vasca in ottone cromato, serie Liberty, 3/4M x 3/4M.
Couple c.p. brass vertical connections for bath mixer, serie Liberty, 3/4M x 3/4M.

88 01 LI S  CR € 597,00
Coppia colonne vasca in ottone cromato, serie Liberty, con supporto doccia, 3/4M x 3/4M.
Couple c.p. brass vertical connections for bath mixer, serie Liberty, with hand shower holder 3/4M x 3/4M.

88 N 02  CR € 402,30
Coppia colonne vasca in ottone cromato, serie Minimal, con supporto doccia, 3/4M x 3/4M.
Couple c.p. brass vertical connections for bath mixer, serie Minimal, with hand shower holder 3/4M x 3/4M.

RACCORDERIA
FITTINGS

ACCESSORI
ACCESSORIES

COMPONENTI PLASTICI
PLASTIC COMPONENTS

88 UK  CR € 53,30
Coppia colonnette bordo vasca in ottone cromato, serie UK, 3/4Mx3/4M.
Couple c.p. brass vertical connections for bath mixer, serie Minimal, with hand shower holder 3/4M x 3/4M.

88 LI  CR € 72,30
Coppia colonnette bordo vasca in ottone cromato, serie Liberty, 3/4M x 3/4M.
Couple c.p. brass vertical connections for bath mixer, serie Liberty, 3/4M x 3/4M.

88  CR € 18,80
Colonneta per bordo vasca in ottone cromato, 1/2M x 3/4M.
C.P. brass vertical connection for bath mixer, 1/2M x 3/4M.

88 BI  € 23,50
Colonneta per bordo vasca, verniciata bianca, 1/2M x 3/4M.
Vertical connection for bath mixer in white colour, 1/2M x 3/4M.

BOCCHIE - SPOUTS



86 CR € 10,40
Canna lavello inferiore a "S", tipo universale, con aeratore.
Lower "S" sink spout, universal type, with aerator.



86 N CR € 9,50
Canna lavello inferiore a "S", cm 20, con aeratore.
Lower "S" sink spout, cm 20, with aerator.



86 N 40 CR € 14,80
Canna lavello inferiore a "S", cm 40, con aeratore.
Lower "S" sink spout, cm 40, with aerator.

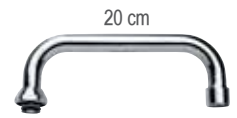

86 U CR € 9,50
Canna lavello superiore a "U", cm 20, con aeratore.
Upper "U" sink spout, cm 20, with aerator.



87 N CR € 11,30
Canna a "J" per monoforo lavello, con aeratore.
"J" spout for one-hole sink, with aerator.



87 CR € 14,60
Canna a "J" per monoforo lavello, tipo universale, con aeratore.
"J" spout for one-hole sink, universal type, with aerator.



92 C CR € 26,10
Canna a biscotto a "C" con calotta da 3/4, con aeratore.
"C" spout with nut 3/4, with aerator.



92 CC CR € 22,60
Canna a biscotto a "C" con calotta da 3/4, con aeratore, tipo corto.
"C" spout with nut 3/4, with aerator, short type.



92 U CR € 24,50
Canna a "U" Ø 22, con aeratore.
"U" spout Ø 22, with aerator.

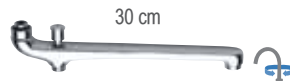

93 CR € 53,80
Canna fusa lunga cm 30 con deviatore, con calotta da 3/4 ed aeratore.
Casted cm 30 long spout with diverter, with 3/4 nut, with aerator.



92 16 CR € 16,10
Canna a biscotto diritta, calotta da 3/4, lunghezza cm.16, con aeratore.
Straight spout with 3/4 nut, 16 cm long, with aerator.



92 20 CR € 18,10
Canna a biscotto diritta, calotta da 3/4, lunghezza cm.20, con aeratore.
Straight spout with 3/4 nut, 20 cm long, with aerator.



92 30 CR € 20,30
Canna a biscotto diritta, calotta da 3/4, lunghezza cm. 30, con aeratore.
Straight spout with 3/4 nut, 30 cm long, with aerator.



92 40 CR € 37,10
Canna a biscotto diritta, calotta da 3/4, lunghezza cm.40, con aeratore.
Straight spout with 3/4 nut, 40 cm long, with aerator.



92 50 CR € 40,00
Canna a biscotto diritta, calotta da 3/4, lunghezza cm. 50, con aeratore.
Straight spout with 3/4 nut, 50 cm long, with aerator.



92 S16 € 18,20
Canna a biscotto a "S", calotta da 3/4, lunghezza cm.16, con aeratore.
"S" spout with 3/4 nut, 16 cm long, with aerator.



92 S20 € 20,50
Canna a biscotto a "S", calotta da 3/4, lunghezza cm.20, con aeratore.
"S" spout with 3/4 nut, 20 cm long, with aerator.



92 S30 € 23,10
Canna a biscotto a "S", calotta da 3/4, lunghezza cm.30, con aeratore.
"S" spout with 3/4 nut, 30 cm long, with aerator.

SUPPORTI DOCCIA - SUPPORTS FOR HANDSHOWER



325 07

Supporto per doccia estraibile per bordo lavello e bordo vasca, modello a base tonda.

Support for extensible handshower for deck bath and deck sink, round base model.

CR € 34,80



325 S 07

Supporto dritto per doccia estraibile per bordo lavello e bordo vasca, modello a base quadrata.

Straight support for extensible handshower for deck bath and deck sink, squared base model.

CR € 31,40

MINUTERIA
MINUTERY

VALVOLE
VALVES

SCARICHI - WASTES

RACCORDERIA
FITTINGS

ACCESSORI
ACCESSORIES

COMPONENTI PLASTICI
PLASTIC COMPONENTS



95 TA

Tappo scarico automatico in ottone per piletta 1" e per piletta 1"1/4.
C.p. brass plug for pop-up waste for drain 1" and for drain 1"1/4.

1" € 3,90
1" 1/4 € 4,80



95 TAG

Tappo grande in ottone cromato per scarico automatico con piletta da 1"1/4.
Big plug in c.p. brass for pop-up waste with drain 1"1/4.

€ 12,10



95 TAS

Tappo grande quadrato in ottone cromato per scarico automatico con piletta da 1"1/4.
Squared big plug in c.p. brass for pop-up waste with drain 1"1/4.

€ 20,00



96 TA

Tappo in ottone cromato per colonna vasca automatica.
Chrome plated brass plug for automatic bath waste and overflow.

€ 4,50



BA K10

Basetta in ottone per rubinetteria tipo serie Kiss, Ten, Giga.
Base in c.p. brass for mixers like serie Kiss, Ten, Giga.

€ 6,20



94

Asta per scarico automatico, lunghezza cm 30, in ottone cromato.
Rod for pop-up waste, length 30 cm, in c.p. brass.

€ 3,80



95 AC

Asta e centralina bidet per scarico automatico, in ottone cromato.
Rod and flange for bidet for pop-up automatic waste, in c.p. brass.

€ 21,80



95 Q AC

Asta e centralina bidet per scarico automatico, in ottone cromato.
Rod and flange for bidet for pop-up automatic waste, in c.p. brass.

€ 28,50



AS T10

Asta con pomolo e snodino per serie Ten, in ottone cromato.
Rod with knob and small joint for Ten series, in c.p. brass.

€ 4,80



AS K10

Asta con pomolo e snodino per serie Kiss, in ottone cromato.
Rod with knob and small joint for Kiss series, in c.p. brass.

€ 4,20



FIS K10

Confezione di fissaggio per art. K10, K20, K40.
Fixing set for art. K10, K20, K40.

€ 1,90



FIS R10

Confezione di fissaggio per art. R10, R20, R40.
Fixing set for art. R10, R20, R40.

€ 2,50



FIS T10

Confezione di fissaggio a doppio tirante.
Fixing set with double screw.

€ 2,40



FIS A10

Confezione di fissaggio per: Atmos, Flash, Qubika Cascata.
Fixing set for: Atmos, Flash, Qubika Waterfall.

€ 7,20



FIS B10

Confezione di fissaggio per art. S42 U, S10 G, B10, B20, Q42U, Q10 G.
Fixing set for art. S42 U, S10 G, B10, B20, Q42U, Q10 G.

€ 2,50

ACCESSORI PER LAVABO - WASH BASIN ACCESSORIES



695 € 3,80
 Copriforo per lavabo, Ø mm 50 in ottone cromato, tipo pesante.
 Tap-hole-cover for wash basin Ø 50 mm in C.P. brass, heavy type.



695 BI € 4,30
 Copriforo per lavabo, Ø mm 50 verniciato bianco, tipo pesante.
 Tap-hole-cover for wash basin Ø 50 mm in white color, heavy type.



694 € 1,30
 Copriforo per lavabo Ø mm 44, in acciaio inox.
 Tap-hole-cover for wash basin Ø 44 mm, in stainless steel.



696 € 0,63
 Griglia copripiletta in acciaio inox.
 Grate for sink waste in stainless steel.



696 B € 0,69
 Griglia copripiletta in acciaio inox, Ø esterno mm 70.
 Grate for sink waste in stainless steel, external Ø 70 mm.



692 € 0,86
 Tappo in PVC nero, con maniglia Ø mm 52.
 Plug in black PVC, with handle Ø mm 52.



690
 Tappi con catena e anello, con rosetta copritappo.
 Plugs with chain and chain ring, with coverhole flange.

Ø	40 mm	47 mm	52 mm
	€ 1,70	€ 1,80	€ 1,70



691
 Tappi con catena e reggicatena, con rosetta copritappo.
 Plugs with chain, chain-ring and holder, with coverhole flange.

Ø	27 mm	31 mm
	€ 1,70	€ 1,60

ACCESSORI PER LAVELLO - SINK ACCESSORIES



900 1 1/4 € 12,80
 Pilettoni sifoide per lavello con T.P., senza dado e codulo, 1 1/4.
 Trap waste for sink, with overflow, without nut and connection, 1 1/4.



903 1 1/4 € 9,20
 Piletta simplex 1 1/4.
 Simplex waste 1 1/4.



903 SM 1 1/4 € 6,10
 Piletta gattinara, Ø 70.
 Waste, Ø 70.



880 € 167,50
 Gruppo completo per fontanella, tipo universale, con rubinetto, con ritorno automatico.
 Fountains complete set, universal type with tap with automatic return.



908
 Piletta per lavabo con o senza T.P.
 Sink waste, with or without overflow.

1"	1 1/4"
€ 10,50	€ 13,60

ACCESSORI PER WC ED ORINATOI - WC AND ORINALS ACCESSORIES



699 € 2,00
Pull bianchi con catena a perline.
Pull handle for wc flushing tank, with C.P. chain.

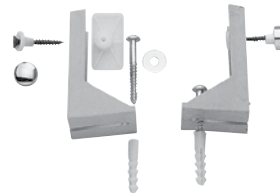

733 € 2,40
Coppia zanche in plastica antiurto a L con viti, per fissaggio laterale W.C. e bidet.
Couple wall brackets in plastic, shock-resistant, L shaped, with screws, for side WC and bidet fixing.



715 € 4,30
Confezione fissa water-bidet composta da 4 viti ottone, 4 dadi ottone, 4 sottoviti, 4 tasselli.
Bag for fixing W.C.-bidet: 4 brass screws, 4 caps, 4 underscrews, 4 nuts.



715 F € 1,40
Confezione fissa water-bidet composta da 4 viti ferro, 4 dadi ottone, 4 sottoviti, 4 tasselli.
Bag for fixing W.C.-bidet: 4 iron screws, 4 caps, 4 underscrews, 4 brass nuts.



715 F2 € 0,66
Confezione fissa water-bidet composta da 2 viti ferro, 2 dadi ottone, 2 sottoviti, 2 tasselli.
Bag for fixing W.C.-bidet: 2 iron screws, 2 caps, 2 underscrews, 2 brass nuts.



745 € 0,70
Coppia supporti per sedile WC, in nylon bianco completa di bulloni con guida.
Set of 2 holding brackets for WC seat, in white nylon, complete with bolts and slide way.



746 € 5,10
Coppia supporti per sedile WC, in ottone cromato con viti di fissaggio.
Set of 2 holding brackets in c.p. brass for WC seat, complete with bolts and slide way

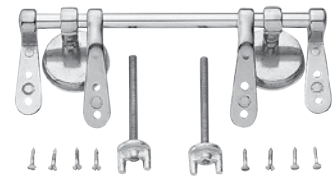

747 € 11,20
Coppia cerniere per sedile WC, in ottone cromato, tipo con tubetto per sedili in legno, con 8 viti in ottone.
Couple hinges for WC seat, in C.P. brass, kind with pipe for wooden seats, with 8 brass screws.

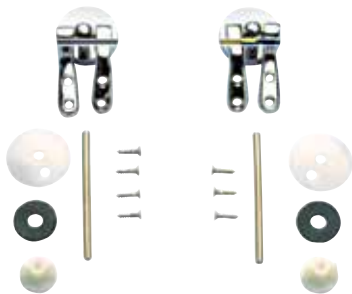

748 € 9,10
Coppia cerniere per fissaggio sedili W.C. in legno, con 8 viti in ottone.
Couple hinges for fixing W.C. seats, with 8 screws.

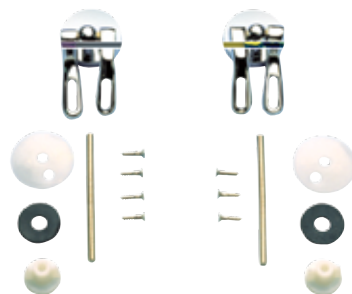

748 UNI € 17,40
Coppia cerniere in ottone cromato, tipo universale, per fissaggio sedili W.C. in legno, con 8 viti in ottone.
Couple hinges in C.P. brass, universal type, for fixing W.C. seats, with 8 screws.



749 € 11,90
Coppia cerniere in ottone cromato, per sedile della serie Conca, con 8 viti ottone.
Couple hinges for WC seat serie Conca, in C.P. brass, with 8 brass screws.



750
Coppia viti con tassello in acciaio per lavabo, lunghezza mm 120, 140.
Bag of 2 screws 120, 140 mm for wash-basin, with plastic nuts.

mm 120 € 1,10
mm 140 € 1,30



751 € 1,80
Coppia viti per lavabo semi incasso con tassello, lunghezza mm 180.
Bag of 2 screws for semi-recessed basin, with nut, length mm 180.

mm 180 € 1,80



752 € 0,84
Coppia viti Ø mm 8 con tassello e dado per cassetta W.C., lunghezza mm 90.
Couple screws Ø mm 8 with plastic screw anchors and nut, for WC flushing tank, length mm 90.

mm 90 € 0,84



755
Coppia tiranti con gancio e tassello in acciaio per scaldabagno, lunghezza mm 75, 100.
Bag of 2 screws, 75, 100 mm for water-heater, with plastic nuts.

mm 75 € 0,75
mm 100 € 0,85

MINUTERIA
MINUTERY

VALVOLE
VALVES

RACCORDERIA
FITTINGS

ACCESSORI
ACCESSORIES

COMPONENTI PLASTICI
PLASTIC COMPONENTS

ACCESSORI - ACCESSORIES



770

Tassello di ricambio Ø6 e Ø8.
Spare dowel Ø 6 and Ø8..

Ø6	Ø8
€ 0,03	€ 0,04



850

Spartiacque curvo per orinatoio 1/2.
Elbow water divide for urinals, 1/2.

€ 28,20



852

Spartiacque dritto per orinatoio 1/2.
Straight water divide for urinals, 1/2.

€ 31,40



854

Piletta a cupola per orinatoio 1"1/4.
Urinal dome drain, 1"1/4.

€ 52,00

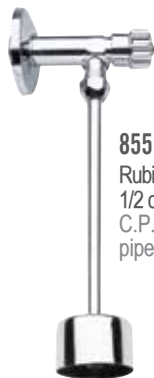

855

Rubinetto per orinatoio a maniglia,
1/2 con tubetto Ø mm 10 e rosone.
C.P. urinal valve, 1/2, with copper
pipe Ø 10 and C.P. brass flanges.

€ 14,50



856

Spartiacque per orinatoio attacco Ø
15, con tubo Ø mm 15.
Water divide for urinal, connection Ø 15,
with pipe Ø mm 15.

€ 26,90



856 CO

Spartiacque per orinatoio attacco Ø 15,
per tubo Ø mm 15.
Water divide for urinal, connection Ø 15,
for pipe Ø mm 15.

€ 16,60



872

Spartiacque curvo con canotto
e rosone, per vasi alla turca in
ceramica in ottone cromato, 1".
Elbow water divide for "Turca" floor
ceramic urinals in c.p. brass, 1".

€ 45,40



857

Spartiacque per orinatoio attacco Ø
15, per tubo Ø mm 15.
Water divide for urinal, connection Ø
15, for pipe Ø mm 15.

€ 9,50



858

Bicchiere per scarico orinatoio, 1" in
ottone cromato, Ø interno mm 60.
Cup for urinal waste, in c.p. brass,
internal Ø mm 60, 1".

€ 32,20



864

Bicchiere per scarico orinatoio, con
sifone a bottiglia in ottone cromato
da 1".
Cup for urinal waste, with bottle trap
in c.p. brass, 1".

€ 38,30

ACCESSORI PER DOCCIA - SHOWER ACCESSORIES

Canaline Sifonate Rettangolari - Rectangulars Floor Drains



913 RG 12

Canalina sifonata a pavimento, in inox, con griglia di drenaggio, larghezza
12.5 cm lunghezze cm 70, 80, 90, 100, 120.
Rectangular floor drain, in stainless steel, with drain grill, large 12.5 cm,
lengths cm 70, 80, 90, 100, 120.

cm70	cm80	cm90	cm100	cm120
€ 548,00	€ 588,00	€ 628,00	€ 668,00	€ 744,00

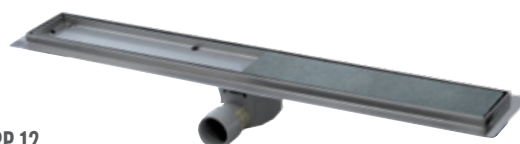

913 RP 12

Canalina sifonata a pavimento, in inox, piastrellabile, larghezza 12,5 cm
lunghezze cm 70, 80, 90, 100, 120.
Rectangular floor drain, in stainless steel, model for tiling, large 12,5 cm,
lengths cm 70, 80, 90, 100, 120.

cm70	cm80	cm90	cm100	cm120
€ 548,00	€ 588,00	€ 628,00	€ 668,00	€ 744,00

Pilette Sifonate - Siphon Drains



913 SF 10 € 63,40
Piletta da pavimento sifonata in inox, cm 10x10.
Stainless steel floor drain and siphon, cm 10x10.



913 SF 15 € 105,60
Piletta da pavimento sifonata in inox, cm 15x15.
Stainless steel floor drain and siphon, cm 15x15.



913 SF 20 € 132,70
Piletta da pavimento sifonata in inox, cm 20x20.
Stainless steel floor drain and siphon, cm 20x20.

MINUTERIA
MINUTERY

VALVOLE
VALVES

RACCORDERIA
FITTINGS

ACCESSORI
ACCESSORIES

COMPONENTI PLASTICI
PLASTIC COMPONENTS

COPERTURA A PAVIMENTO IN ACCIAIO INOX STAINLESS STEEL FLOOR DRAINS



10x10



913 GVC 10 € 20,00
Copertura a pavimento in inox cm 10x10, con griglia fissa e coperchio mobile.
Stainless steel floor drain cm 10x10, with fixed grill and movable plug.



913 GV 10 € 16,50
Copertura a pavimento in inox cm 10x10, con griglia fissa.
Stainless steel floor drain cm 10x10, with fixed grill.

15x15



913 GVC 15 € 27,60
Copertura a pavimento in inox cm 15x15, con griglia fissa e coperchio mobile.
Stainless steel floor drain cm 15x15, with fixed grill and movable plug.



913 GV 15 € 22,60
Copertura a pavimento in inox cm 15x15, con griglia fissa.
Stainless steel floor drain cm 15x15, with fixed grill.



913 CV 15 € 22,60
Copertura a pavimento in inox cm 15x15, con coperchio avvitato fisso.
Stainless steel floor drain cm 15x15, with fixed plug.



913 GFC 15 € 23,60
Copertura a pavimento in inox cm 15x15, con griglia e coperchio mobili.
Stainless steel floor drain cm 15x15, with movable grill and movable plug.

20x20



913 GVC 20 € 33,20
Copertura a pavimento in inox cm 20x20, con griglia fissa e coperchio mobile.
Stainless steel floor drain cm 20x20, with fixed grill and movable plug.



913 GV 20 € 28,00
Copertura a pavimento in inox cm 20x20, con griglia fissa.
Stainless steel floor drain cm 20x20, with fixed grill.



913 CV 20 € 28,00
Copertura a pavimento in inox cm 20x20, con coperchio avvitato fisso.
Stainless steel floor drain cm 20x20, with fixed plug.



913 GFC 20 € 29,20
Copertura a pavimento in inox cm 20x20, con griglia e coperchio mobili.
Stainless steel floor drain cm 20x20, with movable grill and movable plug.

Sifoni Anti Scarafaggio - Anti Cockroach-Insects Trap



913 PSA 01
Sifone anti-scarafaggio da utilizzare per coperture a pavimento cm 15x15 e 20x20.
Anti cockroach-insects to use under the floor drains with size cm 15x15 e 20x20.

cm 15-20

€ 4,50



913 PSA 02
Sifone anti-scarafaggio da utilizzare per coperture a pavimento cm 10x10.
Anti cockroach-insects to use under the floor drains with size cm 10x10.

cm 10x10

€ 3,60

SCARICHI AUTOMATICI - POP-UP WASTES



95 €12,20
Scarico automatico 1", 1 1/4".
C.P. brass pop-up waste, 1", 1 1/4".



95 L €15,30
Scarico automatico da 1 1/4", tipo Lusso.
C.P. brass pop-up waste 1 1/4", luxury type.



95 U €19,70
Scarico automatico da 1 1/4", tipo lusso lucidato.
C.P. polished pop-up waste, 1 1/4", luxury type.



95 AM €25,90
Scarico tipo America o Americano, in ottone pulito e cromato.
C.p. waste model America or American, polished and in c.p. brass.



95 UG €23,70
Scarico automatico da 1 1/4", tipo lusso lucidato, con tappo grande a copertura totale della piletta.
C.P. polished pop-up waste, 1 1/4", luxury type with big plug covering the drain.



95 P €4,30
Scarico automatico in plastica da 1 1/4".
Plastic pop-up waste, 1 1/4".



95 US €38,60
Scarico automatico da 1 1/4", tipo lusso lucidato, con tappo grande quadrato piatto a copertura totale della piletta.
C.p. polished pop-up waste, 1 1/4", luxury type with big squared flat plug covering the drain.

SCARICHI AUTOMATICI CLICK-CLACK
AUTOMATIC CLICK-CLACK POP-UP WASTES



904 CC 2 1 1/4 €29,90
Scarico automatico con sistema click-clack, 1 1/4", e tappo grande, senza troppo pieno, modello con bicchiere corto.
Automatic pop-up waste 1 1/4", click-clack system, big plug, without overflow, model with shorter cup.



904 CC 1 1/4 €33,30
Scarico automatico con sistema click-clack, 1 1/4", e tappo grande, senza troppo pieno.
Automatic pop-up waste 1 1/4", click-clack system, big plug, without overflow.



904 SCC 2 1 1/4 €37,20
Scarico automatico quadrato 1 1/4" con click-clack senza troppo pieno, modello con bicchiere corto.
Squared automatic pop-up waste 1 1/4" with click-clack system without overflow, model with shorter cup.



904 SCC 1 1/4 €40,70
Scarico automatico quadrato 1 1/4" con click-clack senza troppo pieno.
Squared automatic pop-up waste 1 1/4" with click-clack system without overflow.



906 CC 2 1"1/4 € 26,30
 Scarico automatico con sistema click-clack, 1"1/4, con troppo pieno, modello con bicchiere corto.
 Automatic pop-waste 1"1/4, click-clack system, with overflow, model with shorter cup.



906 CC 1"1/4 € 29,90
 Scarico automatico con sistema click-clack, 1"1/4, con troppo pieno.
 Automatic pop-up waste 1"1/4, click-clack system, with overflow.



905 CC 2 1"1/4 € 29,90
 Scarico automatico con sistema click-clack, 1"1/4, e tappo grande, con troppo pieno, modello con bicchiere corto.
 Automatic pop-up waste 1"1/4, click-clack system, big plug, with overflow., model with shorter cup



905 CC 1"1/4 € 33,30
 Scarico automatico con sistema click-clack, 1"1/4, e tappo grande, con troppo pieno.
 Automatic pop-up waste 1"1/4, click-clack system, big plug, with overflow.



905 SCC 2 1"1/4 € 37,20
 Scarico automatico quadrato 1"1/4 con click-clack con troppo pieno, modello con bicchiere corto.
 Squared automatic pop-up waste 1"1/4 with click-clack system with overflow, model with shorter cup.



905 SCC 1"1/4 € 40,70
 Scarico automatico quadrato 1"1/4 con click-clack con troppo pieno.
 Squared automatic pop-up waste 1"1/4 with click-clack system with overflow.



907 2 1"1/4 € 40,30
 Scarico automatico 1"1/4 con tappo grande sempre aperto e sistema click-clack per la pulizia interna, modello con bicchiere corto.
 Automatic pop-up waste 1"1/4 with big plug always opened, and click-clack system for internal cleaning, model with shorter cup.



907 1"1/4 € 43,70
 Scarico automatico 1"1/4 con tappo grande sempre aperto e sistema click-clack per la pulizia interna.
 Automatic pop-up waste 1"1/4 with big plug always opened, and click-clack system for internal cleaning.



905 CCR 1"1/4 € 30,90
 Scarico automatico universale con chiusura click-clack da 1"1/4.
 Universal automatic pop-up waste 1"1/4 with click-clack system.

NEW



905 CC XL 1"1/4 € 49,20
 Scarico automatico con sistema click-clack, 1" 1/4, tappo grande, con troppo pieno, versione extralunga.
 Automatic pop-up waste 1"1/4, click-clack system, big plug, with overflow, extralong version.

NEW

MINUTERIA
MINUTERY

VALVOLE
VALVES

RACCORDERIA
FITTINGS

ACCESSORI
ACCESSORIES

COMPONENTI PLASTICI
PLASTIC COMPONENTS

SIFONI - TRAPS



977 1"1/4 € 21,90
Sifone a "P" in tubo, in ottone cromato, 1" 1/4".
"P" trap made by tube, in c.p. brass, 1" 1/4".



NEW
977X 1"1/4 € 15,20
Sifone "P" in tubo, in acciaio INOX, 1" 1/4.
"P" trap made by tube, in stainless steel, 1" 1/4.



970
Sifone a bottiglia in ottone cromato, canotto cm 25, 1", 1" 1/4.
C.P. brass bottle trap, 25 cm outlet tube, 1", 1" 1/4.

1"	1"1/4
€ 27,60	€ 32,30



970 Z 1"1/4 € 17,80
Sifone a bottiglia in zama senza piletta, per lavabo, 1" 1/4, canotto cm. 30.
Bottle trap in zamac without waste, for wash-basin, 1" 1/4, outlet tube cm 30.



971
Sifone a "S" in ottone cromato, canotto cm 25, 1", 1" 1/4.
C.P. brass "S" trap, 25 cm outlet tube, 1", 1" 1/4.

1"	1"1/4
€ 28,40	€ 30,80



971 Z 1"1/4 € 14,80
Sifone a "S" in zama, canotto cm 25, 1" 1/4.
"S" trap in zamac, 25 cm outlet tube, 1" 1/4.



972
Sifone a "U" per lavabo a colonna in ottone cromato, canotto cm 25, 1", 1" 1/4.
C.P. brass "U" trap, 25 cm outlet tube, 1", 1" 1/4.

1"	1"1/4
€ 28,80	€ 38,40

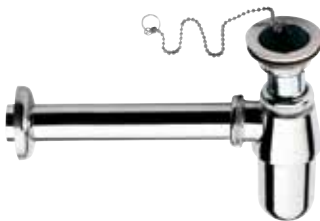

973 Z 1"1/4 € 23,40
Sifone a bottiglia in zama con piletta, per lavabo, 1" 1/4.
Bottle trap in zamac with waste, for wash-basin, 1" 1/4.

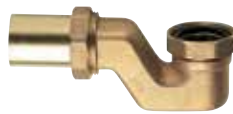

98 1"1/2 € 26,30
Sifone pesante in ottone fuso, con dado 1"1/2 per colonna vasca.
Heavy trap in casting brass, with nut 1"1/2 for bath waste and overflow.



968
Ghiera per sifoni in ottone cromato, 1" M x 1"1/4 F, 1"1/4 M x 1"1/2 F.
C.P. brass reduction for trap 1" M x 1"1/4 F, 1"1/4 M x 1"1/2 F.

1" M x 1"1/4 F	1"1/4 M x 1"1/2 F
€ 3,70	€ 4,40



969
Ghiera per sifoni in ottone cromato, 1"1/4 M x 1" F, 1"1/2 M x 1"1/4 F.
C.P. brass reduction for trap 1"1/4 M x 1" F, 1"1/2 M x 1"1/4 F.

1"1/4 M x 1" F	1"1/2 M x 1"1/4 F
€ 4,40	€ 4,20

SIFONI - TRAPS



MINUTERIA
MINUTERY

VALVOLE
VALVES

RACCORDERIA
FITTINGS

ACCESSORI
ACCESSORIES

COMPONENTI PLASTICI
PLASTIC COMPONENTS



958 L 1"1/4 € 55,40
Sifone "MINIMAL" in ottone cromato, per lavabo, 1"1/4, canotto cm 30 e rosone pesante.
C.P. brass "MINIMAL" P trap, for wash-basin, 1"1/4, outlet tube cm 30 and heavy flange.



958 B 1"1/4 € 49,20
Sifone "MINIMAL" in ottone cromato, per bidet, 1"1/4, canotto cm 30 e rosone pesante.
C.P. brass "MINIMAL" P trap, for bidet, 1"1/4, outlet tube cm 30 and heavy flange.



960 1"1/4 € 66,40
Sifone SQ, in ottone cromato, canotto cm 30, 1"1/4, con rosone pesante quadrato in ottone cromato.
C.p. brass SQ trap, 30 cm outlet tube, 1"1/4, with heavy square wall flange.



965 1"1/4 € 53,50
Sifone esagonale in ottone cromato, 1"1/4, canotto cm 30 e rosone pesante.
C.p. brass hexagonal P trap, 1"1/4, outlet tube cm 30 and heavy flange.



956
Sifone fuso pesante lusso in ottone cromato, per lavabo e bidet 1", 1" 1/4 canotto cm 30.
C.P. brass luxury "P" trap, heavy type, 1", 1" 1/4, outlet tube cm 30.

1"	1"1/4
€ 25,80	€ 44,80

SIFONI SALVASPAZIO - SAVE-SPACING TRAPS



985 € 189,00
Sifone salvaspazio con piletta click-clack incorporata con troppo pieno, rotondo, cromato.
Save-spacing siphon with click-clack built-in drain with overflow, round, chrome.



984 € 189,00
Sifone salvaspazio con piletta click-clack incorporata senza troppo pieno, rotondo, cromato.
Save-spacing siphon with click-clack built-in drain without overflow, round, chrome.

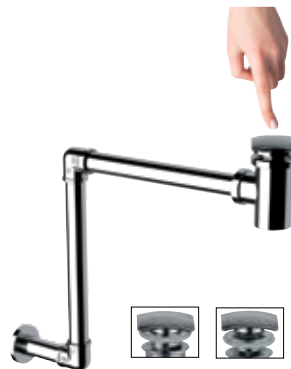

985 S € 195,00
Sifone salvaspazio con piletta click-clack incorporata con troppo pieno, quadrato, cromato.
Save-spacing siphon with click-clack built-in drain with overflow, squared, chrome.



984 S € 195,00
Sifone salvaspazio con piletta click-clack incorporata senza troppo pieno, quadrato, cromato.
Save-spacing siphon with click-clack built-in drain without overflow, squared, chrome.

**COLONNE DI SCARICO
BATH WASTES**



96 P € 35,50
Colonna di scarico automatica in plastica con filo esterno, senza dado e codulo.
Plastic combined bath waste with automatic pop-up with external wire.



96 PCC € 38,80
Colonna di scarico in plastica, con piletta "click-clack".
Plastic combined bath waste and overflow, "click-clack" waste system.



96 LI CC € 268,30
Colonna di scarico con sifone per vasca con tubo in rame cromato e piletta click-clack, tutta cromata.
Bath brass waste with siphon, trap, chromated copper tube and click clack waste, all in chrome plated.



96 LI T € 203,00
Colonna di scarico con sifone per vasca con tubo in rame cromato, tutta cromata.
Bath brass waste with siphon, trap and chromated copper tube, all in chrome plated.



96 € 62,30
Colonna di scarico automatica con filo esterno e tubo in rame senza dado e codulo.
C.P. brass automatic bath waste and overflow with external wire and copper tube.



96 CC € 53,50
Colonna di scarico con tubo in rame, con piletta "click-clack".
C.P. brass waste and overflow with copper tube and "click-clack" waste.



96 VA € 74,10
Colonna di scarico automatico con filo esterno e tubo in rame cm 70, per vasca ad angolo.
C.P. brass automatic bath waste, overflow and copper tube, cm 70, for bath tube edge.

ACCESSORI - ACCESSORIES



910 1"1/4 €15,40
Piletta doccia sifone, 1"1/4.
Trap drain for shower tray 1"1/4.



913 1"1/4 €33,90
Piletta sifoide per piatto doccia, foro Ø 80, tipo a pozzetto, 1"1/4.
Drain trap for shower tray, in brass, Ø 80, 1"1/4.



918 A €3,90
Cestello pesante fuso in ottone cromato alto per pilettone lavello.
C.p. brass high casted plug for sink waste.

918 B €3,70
Cestello pesante fuso in ottone cromato basso per pilettone vasca.
C.p. brass short casted plug for bathtub waste.



922 Ø 100 €7,90
Tappo ad espansione a 3 viti per sifone a pavimento, Ø 100 mm.
Expansion plug with 3 nuts for floor trap, Ø 100 mm.



930 €1,60
Copritappo inox Ø mm 135, con vite da 1/4.
Stainless steel plug cover Ø mm 135, with 1/4 screw.



915 CD 1"1/4 €4,90
Codulo diritto con dado, 1"1/4.
Straight connection with nut, 1"1/4.



915 CC 1"1/4 €6,20
Codulo curvo con dado, 1"1/4.
Elbow connection with nut, 1"1/4.

ACCESSORI PER SCALDABAGNO - WATER HEATER ACCESSORIES



1111 1"1/4 €12,30
Resistenza per scaldabagno attacco 1"1/4 filettata, Watts 1200.
Straight heating element for water heater, 1"1/4, threaded cap, Watts 1200.

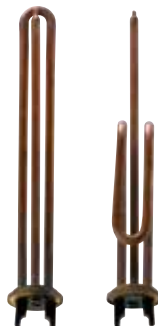

1121 1"1/4 €10,90
Resistenza per scaldabagno attacco con flangia, Watts 1200.
Straight heating element for water heater, 1"1/4, flanged cap, Watts 1200.



1121 AR 1"1/4 €12,50
Resistenza per scaldabagni Ariston, con flangia, con tubetti prolungati, Watts 1200.
Straight heating element for Ariston water heater, 1"1/4, flanged cap with longer pipes, Watts 1200.

1112 1"1/4 €12,90
Resistenza per scaldabagno ricurva attacco 1"1/4 filettata, Watts 1200.
Bent heating element for water heater, 1"1/4, threaded cap, Watts 1200.

1122 1"1/4 €11,40
Resistenza per scaldabagno ricurva attacco con flangia, Watts 1200.
Bent heating element for water heater, 1"1/4, flanged cap, Watts 1200.

1122 AR 1"1/4 €12,80
Resistenza ricurva per scaldabagni Ariston, con flangia, con tubetti prolungati, Watts 1200.
Bent heating element for Ariston water heater, 1"1/4, flanged cap with longer pipes, Watts 1200.



1100 1"1/4 €7,30
Termostato per resistenza per scaldabagno, 1"1/4.
Round thermostat for water heater, 1"1/4.



1130 €0,23
Guarnizione OR mm 36,10x43,16x3,53, per resistenza flangiata.
Oring washer in NBR mm. 36,10x43,16x3,53, for flanged heating elements.



1131 €0,20
Guarnizione esente amianto Ø 44x51, per resistenza filettata.
Asbestosfree washer for threaded heating elements, Ø 44x51.



1132 €0,23
Guarnizione in gomma anticalore (EPDM) 755H, Ø 44,5x36x4, per resistenza filettata.
Oring washer in EPDM, heating resistant, 755 H mm. 44,5x36x4, for threaded heating elements.

MINUTERIA
MINUTERY

VALVOLE
VALVES

RACCORDERIA
FITTINGS

ACCESSORI
ACCESSORIES

COMPONENTI PLASTICI
PLASTIC COMPONENTS



COMPONENTI PLASTICI PLASTIC COMPONENTS



COMPONENTI PLASTICI - PLASTIC COMPONENTS

MINUTERIA
MINUTERY

VALVOLE
VALVES

RACCORDERIA
FITTINGS

ACCESSORI
ACCESSORIES

COMPONENTI PLASTICI
PLASTIC COMPONENTS



COMPONENTI PLASTICI - PLASTIC COMPONENTS



551 € 2,80
 Ermetic-past - Guampast (cartoni da 60 barattoli) in barattoli da Kg. 0,500.
 Ermetic-past - Guampast, in cans of kgs 0,500 (each box contains 60 cans).



552 € 4,10
 Extra Gas per impianti gas (cartoni da 60 barattoli) in barattoli da Kg.0,500.
 Extra gas, for gas systems, in cans of kgs 0,500 (each box contains 60 cans).



555 € 9,60/Kg
 Stearina in pacchi da Kg. 1.
 Stearine in boxes of 1 Kg each.



570 € 10,50/Kg
 Canapa pettinata in matassine 4x50 g, in balle da kg. 50.
 Combed flax in small strips of 4x50 g, bags of 50 kg.

570 BA € 2,45
 Canapa pettinata in confezione da 200 g.
 Combed flax in bags of 200 g.



140 BL 12 € 1,70
 Tappo di collaudo impianti, filetto in ottone, blu, 1/2".
 Testing plug, thread in brass, blue colour, 1/2.



140 RO 12 € 1,70
 Tappo di collaudo impianti, filetto in ottone, rosso, 1/2".
 Testing plug, thread in brass, red colour, 1/2.



140 BI 12 € 1,70
 Tappo di collaudo impianti, filetto in ottone, bianco, 1/2".
 Testing plug, thread in brass, white colour, 1/2.



140 BL PP € 0,94
 Tappo di collaudo impianti, completamente in plastica blu, 1/2".
 Testing plug, completely in plastic, blue colour, 1/2.



140 RO PP € 0,94
 Tappo di collaudo impianti, completamente in plastica rosso, 1/2".
 Testing plug, completely in plastic, red colour, 1/2.



140 BL 12P € 0,72
 Tappo di collaudo impianti, completamente in plastica, colore blu, filetto 1/2Mx3/4M.
 Testing plug, completely in plastic, blu color, thread 1/2Mx3/4M.



140 RO 12P € 0,72
 Tappo di collaudo impianti, completamente in plastica, colore rosso, filetto 1/2Mx3/4M.
 Testing plug, completely in plastic, red color, thread 1/2Mx3/4M.



140 BI 12P € 0,72
 Tappo di collaudo impianti, completamente in plastica, colore bianco, filetto 1/2Mx3/4M.
 Testing plug, completely in plastic, white color, thread 1/2Mx3/4M.



133 € 0,15
 Rosetta apribile universale in plastica bianca.
 Wall flange, universal type in white plastic.



134 € 0,32
 Rosetta apribile universale in plastica bianca.
 Wall flange, universal type in white plastic.

COMPONENTI PLASTICI - PLASTIC COMPONENTS

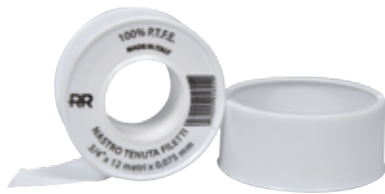

572 10 € 0,32

Nastro P.T.F.E. in rullini da 1/2" per metri 10, spessore 0,075 mm.
P.T.F.E. Tape in rolls of 1/2", meters 10, thickness mm 0,075.

572 12 € 0,37

Nastro P.T.F.E. in rullini da 1/2" per metri 12, spessore 0,075 mm.
P.T.F.E. Tape in rolls of 1/2", meters 12, thickness 0,075 mm.

572 3/4 € 0,61

Nastro P.T.F.E. in rullini da 3/4, mm 19, per metri 12, spessore 0,075 mm. P.T.F.E. Tape in rolls of 3/4 (19 mm), meters 12, thickness 0,075 mm.

572 1" € 0,88

Nastro P.T.F.E. in rullini da 1", mm 24, per metri 12, spessore 0,075 mm.
P.T.F.E. Tape in rolls of 1", (24 mm), meters 12, thickness 0,075 mm.



572 € 0,29

Nastro P.T.F.E. in rullini da 1/2" per metri 8, spessore 0,075 mm, stampato "RR".
P.T.F.E. Tape in rolls of 1/2", meters 8, thickness mm 0,075 with RR printed.



577 € 2,35

Nastro P.T.F.E. in rullini da mm 19,05 per metri 30, spessore mm 0,12, densità 0,30 g/cm³.
P.T.F.E. in rolls of 19,05 mm, meters 30, thickness 0,12 mm, 0,30 g/cm³ density.



553 € 11,10

Sigillante anaerobico flaconcino da 75ml.
Anaerobic sealant, 75ml vial.



573 € 1,32

Nastro P.T.F.E. giallo professionale per gas, in rullini da mm 12 per metri 10, spessore mm 0,10, densità 1,20 g/cm³.
P.T.F.E. professional yellow tape for gas, in rolls of 12 mm, meters 10, thickness 0,10 mm, 1,20 g/cm³ density.



574 € 0,51

Nastro P.T.F.E. in rullini da mm 12 per metri 12, spessore mm 0,10.
P.T.F.E. Tape in rolls of 12 mm, meters 12, thickness 0,10 mm.



575 € 1,85

Nastro P.T.F.E. professionale per gas in rullini da mm 19 per metri 15, spessore mm 0,20.
P.T.F.E. Professional Tape for gas, in rolls of 19 mm, meters 15, thickness 0,20 mm



579 € 16,80

Filo in P.T.F.E. professionale per ogni tipo di tubo in metallo e plastica di Ø inferiore a 6", per metri 150.
P.T.F.E. professional floss tape for pipe in metal or plastic, Ø up to 6", meters 150.



554 € 5,90/Kg

Liquido anticongelante ecologico puro tanica da 25kg.
Pure ecological antifreeze liquid. 25kg tank.

MINUTERIA
MINUTERY

VALVOLE
VALVES

RACCORDERIA
FITTINGS

ACCESSORI
ACCESSORIES

COMPONENTI PLASTICI
PLASTIC COMPONENTS

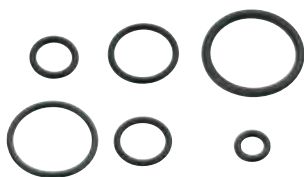

649

Anelli O'RING: in gomma NBR, rettificati, per tenuta a 120°C.
O-RINGS: in NBR rubber, applicable up to 120°C.

R3	8,0X4,2X1,9	€ 0,045	R7	12,7X8,9X1,9	€ 0,045
R4	8,7X4,9X1,9	€ 0,045	R8	14,3X8,9X1,9	€ 0,08
R5	9,5X5,7X1,9	€ 0,045	R9	15,9X10,5X1,9	€ 0,08
R5A	10,2X6,4X1,9	€ 0,045	R10	17,5X12,1X1,9	€ 0,08
R6	11,0X7,2X1,9	€ 0,045	R11	19,0X13,6X1,9	€ 0,08
R6A	11,8X8,0X1,9	€ 0,045	R12	20,5X15,1X1,9	€ 0,08



648

€ 10,80

Scatola con 430 anelli "OR" per vitoni del tipo originale rettificato, assortiti in 12 misure da Ø esterno mm 8 al Ø esterno mm 20,5.

Box of 430 "OR" rings, assorted in 12 measures from external Ø mm 8 to external Ø mm 20,5.

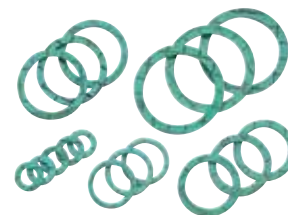

650

Guarnizioni per raccordi senza amianto spessore mm 2 in conf. 100 pz.

Green washers, without asbestos in bags of 100 pcs thickness.

3/8	1/2	3/4	
€ 0,026	€ 0,032	€ 0,05	
1"	1"1/4	1"1/2	2"
€ 0,058	€ 0,08	€ 0,12	€ 0,19

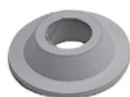

652

Guarnizioni coniche in gomma bianca.
Washer conical seat in white rubber.

1/2	3/4	
€ 0,29	€ 0,52	
1"	1"1/4	1"1/2
€ 0,42	€ 0,43	€ 0,65



653

Guarnizioni con bordino in gomma bianca.
Washer with reinforcement collar in white rubber.

1/2	3/4	
€ 0,22	€ 0,34	
1"	1"1/4	1"1/2
€ 0,34	€ 0,65	€ 0,65



658-2

Guarnizioni per radiatori in ghisa, spessore mm 2, misure 1", 1"1/4.

Washer for iron radiators, thickness mm 2, size 1", 1"1/4.

1"	1"1/4
€ 0,22	€ 0,26



662 FI

Guarnizione sede piana con filtro retinato.
Washer plain seat with net filter.

1/2	3/4
€ 0,29	€ 0,39



661 CN 18

€ 0,15

Guarnizioni sede tonda Ø18 in gomma NBR per canne lavello.

Washers round seat in black Ø18, rubber NBR, for sink spout.

659-1

1" € 0,16

Guarnizioni per radiatori in alluminio, spessore mm 1, 1".

Washer for aluminium radiators, thickness mm 1, size 1".

659-2

1" € 0,16

Guarnizioni per radiatori in alluminio, spessore mm 2, 1".

Washer for aluminium radiators, thickness mm 2, size 1".



661

Guarnizioni sede tonda in gomma NBR.
Washers round seat in black rubber NBR.

3/8	1/2	3/4
€ 0,06	€ 0,09	€ 0,09
1"	1"1/4	1"1/2
€ 0,10	€ 0,12	€ 0,16



662

Guarnizioni sede piana in gomma nera.
Washers plane seat in black rubber.

3/8	1/2	3/4
€ 0,06	€ 0,07	€ 0,08
1"	1"1/4	1"1/2
€ 0,10	€ 0,12	€ 0,12



663

Guarnizione sede conica in gomma nera.
Washer conical seat in black rubber.

3/8	1/2	3/4	
€ 0,10	€ 0,10	€ 0,10	
1"	Ø 30	1"1/4	1"1/2
€ 0,15	€ 0,13	€ 0,16	€ 0,19

COMPONENTI PLASTICI - PLASTIC COMPONENTS

MINUTERIA
MINUTERY

VALVOLE
VALVES

RACCORDERIA
FITTINGS

ACCESSORI
ACCESSORIES

COMPONENTI PLASTICI
PLASTIC COMPONENTS



665

Guarnizione sede rubinetto in gomma, collaudate a 200.000 chiusure con acqua a 80°.
Water taps sealing with hole, in rubber tested with 200.000 cycles.

3/8	1/2
€ 0,16	€ 0,18



666

Guarnizioni sede rubinetto in gomma, con foro.
Wall tap sealing with hole, in rubber.

3/8	1/2	3/4
€ 0,07	€ 0,08	€ 0,16



666 SI

Guarnizioni sede rubinetto in silicone bianche.
Water tap sealing in white silicone.

3/8	1/2
€ 0,10	€ 0,12



669

Guarnizioni a scodellino in gomma nera.
Washer, cup shaped, in black rubber.

Ø18,5	Ø21	Ø24
€ 0,07	€ 0,11	€ 0,14



669 CA

Guarnizioni a scodellino per galleggiante Catis originale Ø 20 mm con perno.
Washer cup shaped for original Catis float valve, Ø 20 mm, with dowel.

€ 0,21



669 RE

Guarnizioni a scodellino per galleggiante art. 176, 174 AS.

€ 0,15

Washer cup shaped for ofloat valve art.176, 174 AS.



671 PU

€ 1,17

Anello in para Ø esterno mm 60 - interno mm 44, sezione a U per cassetta Pucci.
Caoutchouc rubber external Ø mm 60, internal Ø mm 44, with U section for Pucci WC flushing tank.



671 ID

€ 0,70

Guarnizione per Idronitor in para Ø esterno mm 68, Ø foro interno mm 33.
Washer for Idronitor in caoutchouc rubber, external Ø mm 68, internal hole Ø mm 33.



672 KB

€ 0,53

Membrana in para Ø esterno mm 58,5, Ø foro mm 18,5 per cassetta Kariba.
Caoutchouc rubber flushing tank bottom seal washer, suitable for Kariba, external Ø mm 58,5, hole Ø mm 18,5.



672 FA

€ 0,79

Membrana in para Ø esterno mm 63, Ø foro mm 22, per cassetta Fait.
Caoutchouc rubber flushing tank bottom seal washer, suitable for Fait, external Ø mm 63, hole Ø mm 22.



672 ID

€ 0,73

Guarnizione per cassetta Idron in para nera, Ø est mm 56, Ø foro mm 25, spessore mm 3,6.
Caoutchouc rubber flushing tank bottom seal washer, suitable for Idron, external Ø mm 56 hole Ø mm 25, thickness mm 3,6.

COMPONENTI PLASTICI - PLASTIC COMPONENTS



673 ND ES

Asta completa con sfera per cassetta Nuova Dora esterna.

Complete set of rod and ball for Nuova Dora external flushing tank.

€ 4,00



673 ND 12

Asta completa con sfera per cassetta Nuova Dora incasso 12 litri.

Complete set of rod and ball for Nuova Dora built-in 12 liters flushing tank.

€ 6,70

673 ND 14

Asta completa con sfera per cassetta Nuova Dora incasso 14 litri.

Complete set of rod and ball for Nuova Dora built-in 14 liters flushing tank.

€ 7,00



679 50 26/32

€ 1,15

Morsetto per W.C. in gomma nera, Ø esterno mm 50, per canotti Ø 26, 30, 32.

Clamp gasket for WC in black rubber, external Ø mm 50, for pipes Ø 26, 30, 32.



679 55 26/32

€ 1,15

Morsetto per W.C. in gomma nera, Ø esterno mm 55, per canotti Ø 26, 30, 32.

Clamp gasket for WC in black rubber, external Ø mm 55, for pipes Ø 26, 30, 32.



679 55 40

€ 0,86

Morsetto per W.C. in gomma nera, Ø esterno mm 55, per canotti Ø 40.

Clamp gasket for WC in black rubber, external Ø mm 55, for pipes Ø 40.



679 60 26/32

€ 1,04

Morsetto per W.C. in gomma nera, Ø esterno mm 60, per canotti Ø 26, 30, 32.

Clamp gasket for WC in black rubber, external Ø mm 60, for pipes Ø 26, 30, 32.



674 CA

€ 1,30

Valvola mezza sfera in para Ø est. mm 35, con nottolino ottone filetto 5/32 per batteria Catis.

Caoutchouc half sphere washer, external Ø mm 35, with brass nut, thread 5/32, for Catis group set.



674 CA SN

€ 1,00

Valvola mezza sfera in para Ø est. mm 35, senza nottolino ottone filetto 5/32 per batteria Catis.

Caoutchouc half sphere washer, external Ø mm 35, without brass nut, thread 5/32, for Catis group set.



676 ND

€ 2,00

Sfera in para Ø esterno mm 55, con foro passante Ø mm 14, per cassetta Nuova Dora.

Ball in caoutchouc rubber for Dora WC flushing tank, external Ø mm 55, with passing hole Ø mm 14.



677

€ 1,15

Raccordo per W.C. in para.

Connection for WC in caoutchouc rubber.



679

€ 0,45

Morsetto per W.C. in gomma, Ø esterno mm 54, per canotti Ø 26, 30, 32.

Clamp gasket for W.C. in rubber, external Ø 54 mm, for pipe Ø 26, 30, 32.

COMPONENTI PLASTICI - PLASTIC COMPONENTS

MINUTERIA
MINUTERY

VALVOLE
VALVES

RACCORDERIA
FITTINGS

ACCESSORI
ACCESSORIES

COMPONENTI PLASTICI
PLASTIC COMPONENTS



680 ST € 0,48

Morsetto per W.C. Standard in gomma bianca, Ø esterno mm 60, per canotti Ø 30, 32.
Clamp gasket for W.C. in white rubber, standard type, external Ø 60 mm, for pipe Ø 30, 32.



680 ST 40 € 1,20

Morsetto per W.C. Standard in gomma bianca, Ø esterno mm 60, per canotti Ø 40.
Clamp gasket for W.C. in white rubber, standard type, external Ø 60 mm, for pipe Ø 40.



680 75 32 € 3,20

Morsetto per W.C. Siphonic in gomma bianca, Ø est mm 75, per canotti Ø 30, 32.
Clamp gasket for WC Siphonic in white rubber, external Ø mm 75, for pipes Ø 30, 32.



680 75 40 € 3,30

Morsetto per W.C. Siphonic in gomma bianca, Ø est mm 75, per canotti Ø 40.
Clamp for WC Siphonic in white rubber, external Ø mm 75, for pipes Ø 40.



682 50/26 € 0,75

Raccordo in gomma nera Nicoll, Ø esterno mm 50, per canotti Ø 26.
Connector in black rubber Nicoll, external Ø 50 mm, for pipe Ø 26.



682 50/32 € 0,75

Raccordo in gomma nera Nicoll, Ø esterno mm 50, per canotti Ø 30, 32.
Connector in black rubber Nicoll, external Ø 50 mm, for pipes Ø 30, 32.



682 50/40 € 0,66

Raccordo in gomma nera Nicoll, Ø esterno mm 50, per canotti Ø 40.
Connector in black rubber Nicoll, external Ø 50 mm, for pipe Ø 40.



683 32 22 € 0,45

Guarnizioni in gomma per curve tecniche e manicotti Nicoll, foro mm 22, Ø esterno mm 32.
Rubber washer for technical bendings and Nicoll connections, hole mm 22, external Ø mm 32.



683 40 22 € 0,50

Guarnizioni in gomma per curve tecniche e manicotti Nicoll, foro mm 22, Ø esterno mm 40.
Rubber washer for technical bendings and Nicoll connections, hole mm 22, external Ø mm 40.



684 50/26/32 € 0,56

Raccordo in gomma nera per Von Roll, Ø esterno mm 50 per canotti Ø 26, 30, 32.
Connector in black rubber for Von Roll, external Ø 50 mm for pipes Ø 26, 30, 32.



684 50 40 € 0,47

Raccordo in gomma nera per Von Roll, Ø esterno mm 50 per canotti Ø 40.
Connector in black rubber for Von Roll, external Ø 50 mm for pipe Ø 40.



686 47 26/32 € 0,44

Raccordo in gomma nera per Geberit, Ø esterno mm 47 per canotti Ø 26, 30, 32.
Connector in black rubber for Geberit, external Ø 47 mm for pipes Ø 26, 30, 32.



686 47 40 € 0,32

Raccordo in gomma nera per Geberit, Ø esterno mm 47 per canotti Ø 40.
Connector in black rubber for Geberit, external Ø 47 mm for pipe Ø 40.

COMPONENTI PLASTICI - PLASTIC COMPONENTS



687 32 26 € 0,40

Raccordo in gomma nera per Redi, Ø esterno mm 32, per canotti Ø 26.
Fitting in black rubber for Redi, Ø external mm 32, for pipe Ø 26.



687 40 26 € 0,60

Raccordo in gomma nera per Redi, Ø esterno mm 40, per canotti Ø 26.
Fitting in black rubber for Redi, Ø external mm 40, for pipe Ø 26.



687 40 32 € 0,56

Raccordo in gomma nera per Redi, Ø esterno mm 40, per canotti Ø 32.
Fitting in black rubber for Redi, Ø external mm 40, for pipe Ø 32.



687 50 26 € 0,95

Raccordo in gomma nera per Redi, Ø esterno mm 50, per canotti Ø 26.
Fitting in black rubber for Redi, Ø external mm 50, for pipe Ø 26.



687 50 32 € 0,85

Raccordo in gomma nera per Redi, Ø esterno mm 50, per canotti Ø 32.
Fitting in black rubber for Redi, Ø external mm 50, for pipe Ø 32.



688 110 90 € 1,46

Collare sottovaso in gomma nera, Ø esterno mm 110, Ø interno mm 90.
Collar in black rubber for under WC bowl, internal Ø mm 90, external Ø mm 110.



688 120 90 € 2,40

Collare sottovaso in gomma nera, Ø esterno mm 120, Ø interno mm 90.
Collar in black rubber for under WC bowl, internal Ø mm 90, external Ø mm 120.



689 € 5,10

Prolunga W.C. in gomma nera, Ø esterno mm 111, Ø interno mm 95, altezza mm 92.
Wc extension in black rubber, external Ø mm 111, internal Ø mm 95, thickness mm 92.



689 B € 1,70

Prolunga W.C. in gomma bianca, Ø esterno mm 111, Ø interno mm 95, altezza mm 92.
W.C. white rubber connector, ext. Ø mm 111, int. Ø mm 95, height mm 92.



689 EC € 1,70

Prolunga W.C. in gomma, eccentrica Ø esterno mm 138, Ø interno mm 100, altezza mm 100.
W.C. white rubber connector, eccentric, ext. Ø mm 138, int. Ø mm 100, height mm 100.



689 ECL € 6,60

Prolunga W.C. in gomma, eccentrica Ø esterno mm 138, Ø interno mm 100, altezza mm 160.
W.C. white rubber connector, eccentric, ext. Ø mm 138, int. Ø mm 100, height mm 160.



689 RI € 6,90

Prolunga W.C. in propilene, eccentrica Ø esterno mm 138, Ø interno mm 100, altezza mm 125.
W.C. white propylene connector, eccentric, ext. Ø mm 138, int. Ø mm 100, height mm 125.



698 € 0,45

Rullino per portarotoli in plastica bianca con molla inox.
Toilet roll holder rod in white plastic with stainless steel spring.



700

Ghiera per troppo pieno per lavabo e bidet, cromata.
C.P. Nut for basin and bidet overflow.

Ø13-19-24 Ø 28

€ 0,70 € 1,10



705 € 1,30

Copriforo per cassetta esterna, in Abs cromato.
Hole cover for external wc flushing tank, in c.p. Abs.



700 DO Ø13-19-24-28 € 4,90

Ghiera per troppo pieno per lavabo e bidet, dorata.
Golden nut for basin and bidet overflow.

COMPONENTI PLASTICI - PLASTIC COMPONENTS



98 P 1"1/4 € 6,90 1"1/2 € 6,90
Sifone in plastica regolabile con dado ottone 1"1/4, 1"1/2 per colonna, con scarico innesto Ø 40, 50, e a saldare. Adjustable low trap for bathtub in black PEHD, inlet nut 1"1/4, 1"1/2, outlet to weld Ø 40, 50.



98 INC 1"1/4 € 6,60 1"1/2 € 7,20
Sifone in plastica regolabile con dado ottone 1"1/4, 1"1/2 per colonna, con scarico ad incollare Ø 32, 40, 50. Adjustable low trap for bathtub in grey PVC, inlet nut 1"1/4, 1"1/2, outlet to glue Ø 32, 40, 50.



911 € 2,70
Sifone in plastica per vasca, 1"1/2 x 40. Siphon for bathtub in white P.P., 1"1/2 x 40.



912 € 6,20
Piletta sifonata Ø 80 per piatto doccia 1"1/2x40. Waste and siphon for shower trays, in white P.P., S.S. grid Ø 80 mm, outlet plastic nut 1"1/2x40.



914 90 € 8,30
Piletta per doccia con piastra cromata Ø 90, con uscita scarico Ø mm 40, per piatto doccia con foro Ø 60 mm. Waste for shower tray, with chrome plated cover Ø 90, outlet pipe mm 40, for shower tray with hole Ø 60 mm.



914 120 € 14,90
Piletta per doccia con piastra cromata Ø 120, con uscita scarico Ø mm 40, per piatto doccia con foro Ø 90 mm. Waste for shower tray, with chrome plated cover Ø 120, outlet pipe mm 40, for shower tray with hole Ø 90 mm.



914 GE € 13,10
Piletta doccia sifoide in plastica con attacco Geberit, piletta in ottone cromato, Ø 40, 50, a saldare. Siphon-waste for shower trays, in black PEHD, C.P. brass waste, outlet to weld Ø 40, 50 mm.



914 INC € 17,50
Piletta doccia sifoide in plastica, piletta in ottone cromato, con attacco ad incollare, Ø 40, 50. Siphon waste for shower trays, in grey PVC, C.P. brass waste, outlet to glue Ø 40, 50 mm.



914 NI € 13,10
Piletta doccia sifoide in plastica, piletta in ottone cromato, con attacco Nicoll, Ø 40. Siphon waste for shower trays, in white P.P., C.P. brass waste, outlet Ø 40, with 1"1/2 plastic nut.



916
Raccordo in plastica curvo per attacco Geberit Ø 40, con dado ottone, 1"1/4, 1"1/2. Elbow plastic connection for Geberit connection Ø 40, with brass nut 1"1/4, 1"1/2.

1"1/4	1"1/2
€ 3,00	€ 5,20

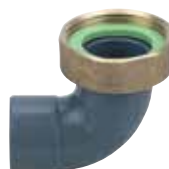

917 C
Raccordo in PVC curvo per attacco Nicoll, con dado ottone, 1"1/4, 1"1/2. Elbow connection in PVC for Nicoll connection, with brass nut, 1"1/4, 1"1/2.

1"1/4	1"1/2
€ 5,30	€ 5,30



917 D
Raccordo in PVC diritto per attacco Nicoll, con dado ottone, 1"1/4, 1"1/2. Straight connection in PVC for Nicoll connection, with brass nut, 1"1/4, 1"1/2.

1"1/4	1"1/2
€ 4,60	€ 4,80

MINUTERIA
MINUTERY

VALVOLE
VALVES

RACCORDERIA
FITTINGS

ACCESSORI
ACCESSORIES

COMPONENTI PLASTICI
PLASTIC COMPONENTS

COMPONENTI PLASTICI - PLASTIC COMPONENTS



931 1"1/2 € 7,60
 Colonna vasca semplice in plastica con tubo di collegamento corrugato in P.P., 1"1/2.
 Corrugated plastic combined waste and overflow set for bathtub, in white P.P., S.S. grid, plug and chain. Male outlet 1"1/2.



932 1"1/2 € 8,00
 Colonna vasca semplice in plastica con tubo di collegamento estensibile in P.P., 1"1/2.
 Extensible plastic combined waste and overflow set for bathtub, in white P.P., S.S. grid, plug and chain. Male outlet 1"1/2.



933
 Canotto flessibile estensibile resistente da +90° a -10°C, colore bianco, con dado in plastica e un manicotto.
 Flexible and extensible plastic tube resisting from +90° to -10°C, white colour, with plastic nut and one coupling.

1" x Ø32 mm	1"1/4 x Ø32 mm	1"1/4 x Ø32/40 mm	1" x 1/2 x Ø40 mm	1"1/2 x Ø40/50 mm
€ 1,30	€ 1,50	€ 1,50	€ 1,50	€ 1,75



936
 Canotto flessibile estensibile resistente da +90° a -10°C, colore bianco, con due manicotti, Ø manicotto mm 32, 40.
 Flexible and extensible tube resisting from +90° to -10°C, white colour, with double coupling Ø mm 32, 40.

Ø 32	Ø 40
€ 1,50	€ 1,50



933 B
 Come 933, con dado in ottone, con rosone art. 933 RO.
 As 933, with brass nut and with flange art. 933 RO.

1" x Ø 32mm	1"1/4 x Ø 32mm	1"1/4 x Ø 32/40mm	1" x 1/2 x Ø 40mm	1"1/2 x Ø 40/50mm
€ 2,10	€ 2,10	€ 2,10	€ 2,20	€ 2,20



933 1005 SM2 € 3,70
 Set composto da canotto flessibile 1"1/2 x Ø mm 40 nostro articolo 933 112 40 + piletta simplex 1"1/2 ns articolo 1005SM112.
 Set composed by flexible and extensible plastic tube 1"1/2 x Ø mm 40 our article 933 112 40 + simplex waste 1"1/2 our article 1005SM112.



933 1005 SM4 € 3,80
 Set composto da canotto flessibile 1"1/4 x Ø mm 32/40 nostro articolo 933 114 3240 + piletta simplex 1"1/4 ns articolo 1005SM114.
 Set composed by flexible and extensible plastic tube 1"1/4 x Ø mm 32/40 our article 933 114 3240 + simplex waste 1"1/4 our article 1005SM114.

COMPONENTI PLASTICI - PLASTIC COMPONENTS



933 RO

Rosone in plastica per art. 933, Ø mm 32, 40.
Plastic flange for art.933, Ø mm 32, 40.

Ø 32	Ø 40
€ 0,20	€ 0,20



933 RI

Riduzione in plastica per art. 933 1"1/2M x 1"1/4F.
Plastic reduction for art.933 1"1/2M x 1"1/4F.

€ 0,30



933 RI 78 112

Riduzione in plastica per art. 933 7/8"F x 1"1/2M.
Plastic reduction for art.933 7/8"F x 1"1/2M.

€ 0,30



943

€ 12,60

Manicotto estensibile e flessibile per W.C. estensibile da 270 mm a 540 mm, resistente e rinforzato in acciaio, guarnizione universale da 90 a 110 mm.
Extensible plastic pipe connection for W.C. reinforced with metal spiral, extensible from 270 to 540 mm, diameter for W.C. from 90 mm to 110 mm.



944

€ 7,20

Tubo estensibile per collegamento w.c., estensibile da mm 230 a mm 570, diametro raccordo w.c. da mm 90 a mm 110.
Flexible and extensible plastic tube for W.C., extensible from 230 mm to 570 mm, diameter for W.C. from 90 mm to 110 mm.

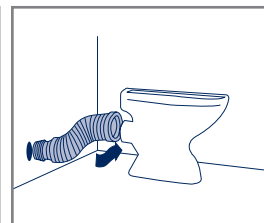
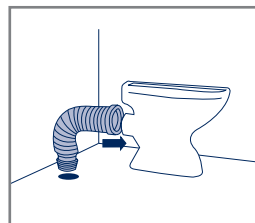
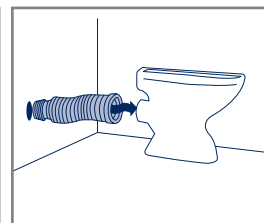
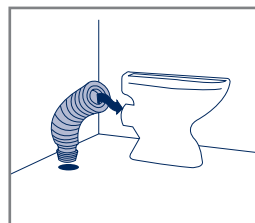

945 C

€ 7,80

Manicotto per W.C., tipo corto, resistente e rinforzato con spirale in filo di nylon, guarnizione universale da 90 a 110 mm, lunghezza cm 40.
Flexible PVC plastic pipe connection for W.C. reinforced with nylon spiral, from 90 mm to 110 mm, length 40 cm.



945 L

€ 8,20

Manicotto per W.C., tipo lungo, resistente e rinforzato con spirale in filo di nylon, guarnizione universale da 90 a 110 mm, lunghezza cm 55.
Flexible PVC plastic pipe connection for W.C. reinforced with nylon spiral from 90 mm to 110 mm, length 55 cm.



943 C

€ 18,70

Manicotto estensibile curvo per w.c., estensibile da 27 a 45 cm, senza troppo pieno.
Extensible plastic pipe with elbow for w.c., extensible from 27 to 45 cm, without overflow.



943 CTP

€ 18,70

Manicotto estensibile curvo per w.c., estensibile da 27 a 45 cm, con troppo pieno.
Extensible plastic pipe with elbow for w.c., extensible from 27 to 45 cm, with overflow.

943 CL

€ 19,20

Manicotto estensibile curvo per w.c., estensibile da 30 a 54 cm, senza troppo pieno.
Extensible plastic pipe with elbow for w.c., extensible from 30 to 54 cm, without overflow.

943 CLTP

€ 19,20

Manicotto estensibile curvo per w.c., estensibile da 30 a 54 cm, con troppo pieno.
Extensible plastic pipe with elbow for w.c., extensible from 30 to 54 cm, with overflow.

MINUTERIA
MINUTERY

VALVOLE
VALVES

RACCORDERIA
FITTINGS

ACCESSORI
ACCESSORIES

COMPONENTI PLASTICI
PLASTIC COMPONENTS



1005

Piletta in polipropilene per lavelli in ceramica, con griglia in acciaio, 1"1/4, 1"1/2.
Waste in polypropylene for ceramic sinks, with S.S. grid, 1"1/4, 1"1/2.

1"1/4	1"1/2
€ 2,25	€ 2,25



1005 SM

Piletta "Simplex" in polipropilene con griglia in acciaio, 1"1/4 (per lavelli in acciaio), 1"1/2 (per lavabo).
Simplex waste in polypropylene, with S.S. grid, 1"1/4 (for stainless steel sinks), 1"1/2 (for wash basin).

1"1/4	1"1/2
€ 2,35	€ 2,35



1025

1"1/2 € 2,60

Piletta in polipropilene senza troppo pieno per lavelli in inox, 1"1/2.
Waste without overflow, in polypropylene, for stainless steel sinks, 1"1/2.



1028

1"1/2 € 13,40

Piletta basket per lavelli, in polipropilene, con griglia e tappo inox, Ø 90 mm, (3"1/2, con filetto uscita 1"1/2).
Waste basket for sinks in polypropylene, with S.S. grid and plug, Ø 90 mm, (3"1/2, outlet thread 1"1/2).



1007

€ 0,85

Riduzione 1"1/4Mx1"1/2F in polipropilene.
Reduction in polypropylene, 1"1/4Mx1"1/2F.



1020

1"1/2 € 3,80

Piletta in polipropilene con troppo pieno per lavelli in inox, 1"1/2.
Waste with overflow, in polypropylene, for stainless steel sinks, 1"1/2.



1015

€ 1,35

Attacco lavatrice universale in polipropilene, 1"1/2x40.
Extension pipe for washing machine, in polypropylene, universal type, 1"1/2x40



1012

Sifone a fiasco a 2 vie senza pilette, in polipropilene.
Flask 2 ways trap in polypropylene without wastes.

1"1/4x32	1"1/4x40	1"1/2x32	1"1/2x40
€ 6,50	€ 6,50	€ 5,90	€ 5,90

COMPONENTI PLASTICI - PLASTIC COMPONENTS



1011

Sifone a fiasco a 1 via senza piletta, in polipropilene.
Flask 1 way trap in polypropylene without waste.

1"1/4x32	1"1/4x40	1"1/2x32	1"1/2x40
€ 4,40	€ 4,40	€ 4,40	€ 4,40



970 P

Sifone tedesco in polipropilene senza piletta.
German bottle trap in polypropylene, without waste.

1"1/4x32	1"1/4x40
€ 4,40	€ 4,40



1233

€ 8,20

Tubo di cacciata per cassetta alta,
universale (45°/90°, 90°/90°).
Connection pipe for high wc tanks,
universal type (45°/90°, 90°/90°).



1230 OR € 0,36

O-ring per art. 1233.
x O-ring for art. 1233.

MINUTERIA
MINUTERY

VALVOLE
VALVES

RACCORDERIA
FITTINGS

ACCESSORI
ACCESSORIES

COMPONENTI PLASTICI
PLASTIC COMPONENTS



COMPANY PROFILE



**TUTTA LA FORZA DI UN GRANDE GRUPPO
ALL THE STRENGTH OF A BIG GROUP**



TUTTA LA FORZA DEL MADE IN ITALY

THE MADE IN ITALY STARTS HERE

TECNOLOGIE ED INVESTIMENTI

Il Gruppo Remer è da sempre alla ricerca di sviluppo e tecnologia e soprattutto negli ultimi anni questo processo ha avuto un incremento notevole che ha portato alla nascita di nuovi stabilimenti di produzione con lo scopo di accentrare tutte le fasi produttive.

All'interno del nostro gruppo si trovano macchinari di ultima generazione che permettono di realizzare il prodotto finito.

Parliamo di cicli completi che vanno dalla progettazione alla realizzazione dei manufatti, tutto all'interno dei nostri stabilimenti.

Possiamo elencare i nostri macchinari più sofisticati quali (ma non solo):

- numerosi centri di lavoro con robots,
- numerosi centri di lavoro con visori ottici e robots,
- svariate transfer a 3 assi,
- numerose transfer a doppia barra
- torni con caricatori in grande quantità,
- macchinari per il taglio barra piena o forata e in tubo,
- macchinari per il taglio tubi e lavorazione canotti e aste
- impianti per il taglio della lastra di ottone o altri metalli,
- grande dipartimento di stampaggio plastica con numerose macchine multimarca.

TECHNOLOGY AND INVESTMENT

Remer Group has always been searching for innovation and technology and during the last few years this process had a remarkable acceleration that drove to the centralisation of all our production plants between Milan and Bergamo area, to group all our production phases and implement our logistics.

Inside these plants there are the most sophisticated Italian last generation machineries that permit to manufacture until the finished product.

Therefore we are talking about a complete cycle that goes from the design to the finished product.

We can list our sophisticated machineries like (but not only):

- several work stations with robots,
- many work stations with optical viewers and robots
- several 3-ways transfers- several robotised and automatic polishing machines,
- several double bar transfers
- many lathes with loaders
- full bar and tube bar cutters
- pipes cutters and machineries to process tubes and rods
- brass plate or other metals cutters
- forging and injection machines department



Grandi spazi completamente attrezzati con macchinari italiani di ultima generazione.

Large spaces fully equipped with the latest Italian machinery

In più:

- grande area dedicata alla lucidatura e pulitura con numerosi impianti automatici robotizzati e sistemi manuali,
- grande impianto di cromatura ad alta qualità,
- dipartimento per la creazione di stampi,
- grande e sofisticata area test prodotto e controllo qualità,
- spettrometro per analisi materia prima,
- svariate linee automatiche di confezionamento,
- impianti per insacchettamento in automatico,
- macchine taglio spugna,
- imballaggio in termoformato in automatico,
- linee automatiche di confezionamento.
- controllo e gestione della produzione e degli ordini totalmente automatizzata con stazioni pc e radio frequenza in tutti gli stabilimenti.

Furthermore:

- several robotised and automatic polishing machines
- high quality chrome plating system
- tooling and moulds creation laboratory
- sophisticated testing quality control machinery departments
- spectrometer for analysis of raw material
- several automatic packaging
- automatic bagging systems
- sponge-cutters
- thermo format machines
- automatic packaging systems,
- radio frequency automatic orders control in each department



TORNI CNC CON ISOLE ROBOTIZZATE

AUTOMATIC LATHES CNC WITH ROBOTISED ISLANDS



Un connubio perfetto tra l'alto livello di automazione
e la professionalità del nostro personale.

A perfect match between the high level of automation
and the professionalism of our staff

LAVORAZIONI INTERNE

INTERNAL WORKINGS



La precisione è la base dei nostri progetti e segue costantemente tutto il ciclo produttivo.

Precision is the base of our projects and constantly follows all the productive cycle.



La realizzazione dei manufatti è completamente automatizzata e controllata.

The production is totally automated and controlled



ENGINEERING 2:



TRANSFER E CENTRI DI LAVORO PER PRODOTTI FUSI E STAMPATI
TRANSFERS AND WORKING STATIONS FOR CASTED AND FORGED PRODUCTS



Tutta la forza produttiva di macchinari altamente all'avanguardia.

All the productive strength of highly advanced machinery.

TRANSFER AUTOMATICA A 9 STAZIONI CON ROBOT PER LAVORAZIONE CORPI FUSI E STAMPATI **9 STATIONS AUTOMATIC TRANSFER WITH ROBOT FOR PROCESSING CASTED AND FORGED BODIES**



Qualità, velocità e precisione: un macchinario che può lavorare simultaneamente su 9 stazioni lo stampato e il fuso

Quality, fastness and precision: a machine that can work simultaneously forged and casted on 9 stations



TRANSFER CON CARICO E LAVORAZIONE SIMULTANEA DI 2 BARRE DOUBLE BAR TRANSFER WITH LOAD AND SIMULTANEOUS WORKING OF 2 BARS



Precisione e velocità imbattibile per prodotti ad alto consumo



Precision and fastness, unbeatable for high consume products

CENTRI DI LAVORO CON ROBOT WORKING STATIONS WITH ROBOTS



CARICO ROBOTIZZATO DEI PEZZI
PRODUCT ROBOTISED LOAD ON TRANSFER MACHINES

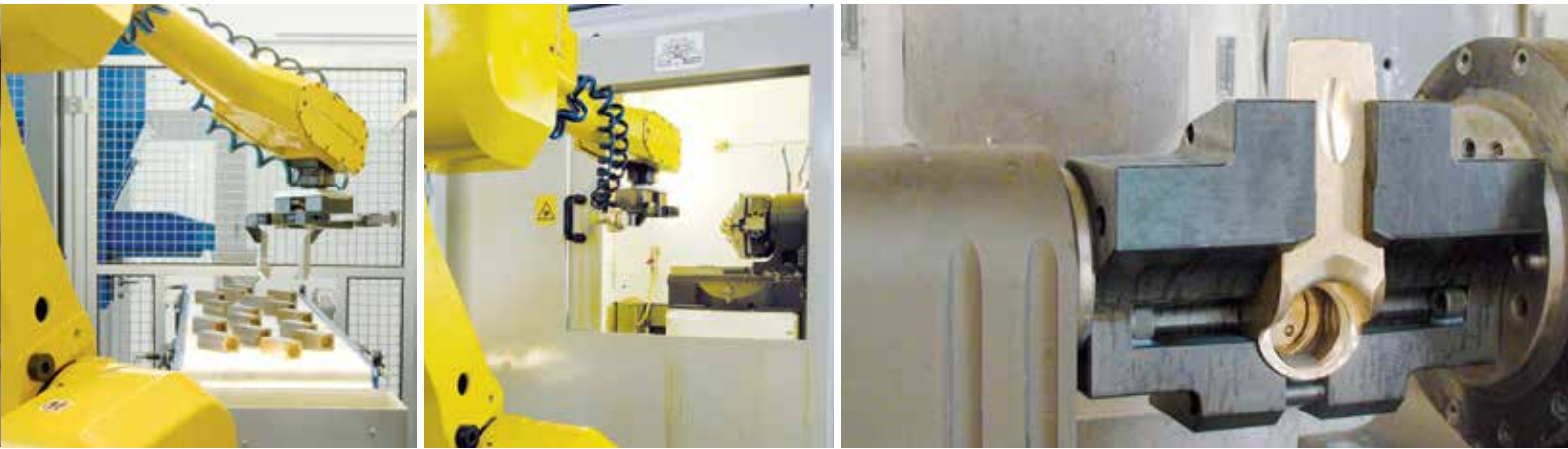

TRANSFER ROBOTIZZATO CON VISORE OTTICO E RIBALTATORE
TRANSFER ROBOT WITH OPTICAL VISUALISER AND TIPPER





CICLO DI PRODUZIONE ASTE SALISCENDI E CANOTTI
SLIDING RAILS RODS, TUBES AND PIPES PRODUCTION CYCLE



MACCHINA AUTOMATICA PER PULITURA ASTE A TAVOLA ROTANTE
ROLLING TABLE RODS CLEANING AND POLISHING AUTOMATIC MACHINE



REPARTO PULITURA
POLISHING DEPARTMENT





**PULITURA E SMERIGLIATURA ROBOTIZZATA E MANUALE
ROBOT AND MANUAL POLISHING AND GRINDING PROCESS**



**MACCHINA PULITURA DOPPIA ROBOTIZZATA
DOUBLE ROBOT POLISHING MACHINE**



**BURATTATURA
TUMBLING**





TAGLIO LASTRA D'OTTONE BRASS PLATE CUTTING

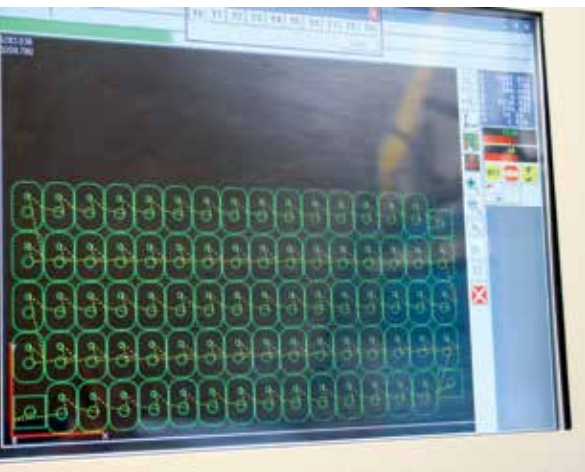

REPARTO CROMATURA CHROME PLATING DEPARTMENT





**REPARTO TRECCIATURA TUBI
FLEXIBLE HOSES BRAIDING DEPARTMENT**



**PRE-ASSEMBLAGGIO AUTOMATICO COMPONENTI
COMPONENTS AUTOMATED PRE-ASSEMBLY**



**PRODUZIONE AUTOMATICA TUBI FLESSIBILI
FLEXIBLE HOSES AUTOMATED PRODUCTION**



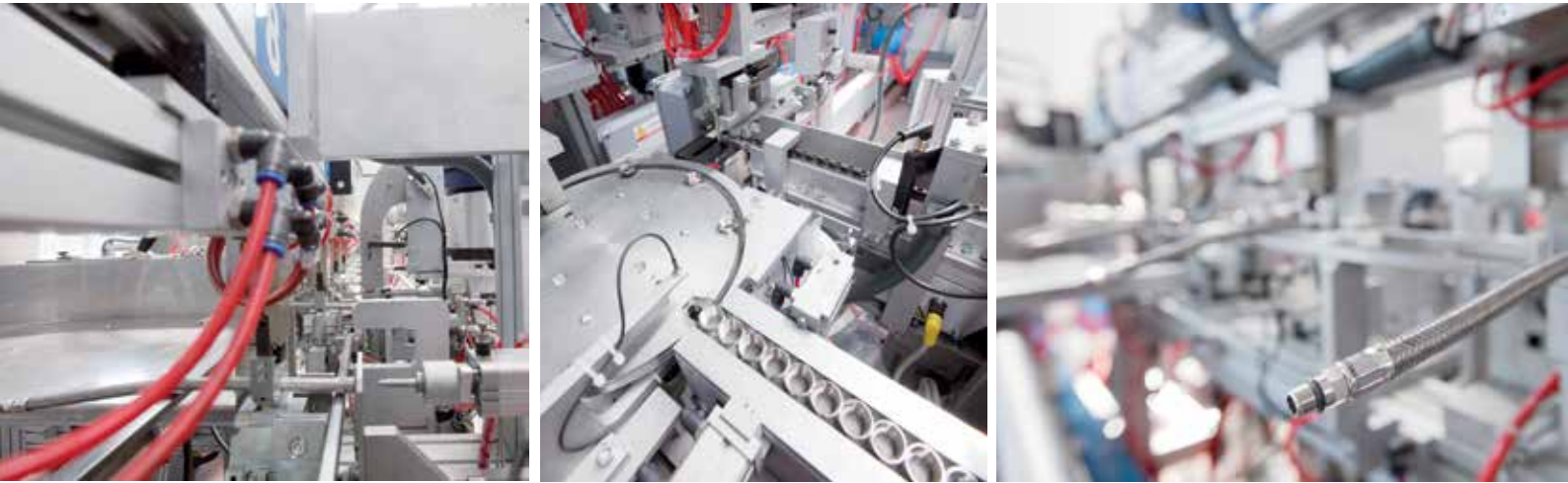

STAMPAGGIO MATERIALI PLASTICI
INJECTION PLASTIC MATERIAL PRESSING DEPARTMENT





**CONTROLLO CROMATURA
CHROME PLATING CONTROL**



**CONTROLLO COMPOSIZIONE MATERIALI
RAW MATERIAL ANALYSIS CONTROL**

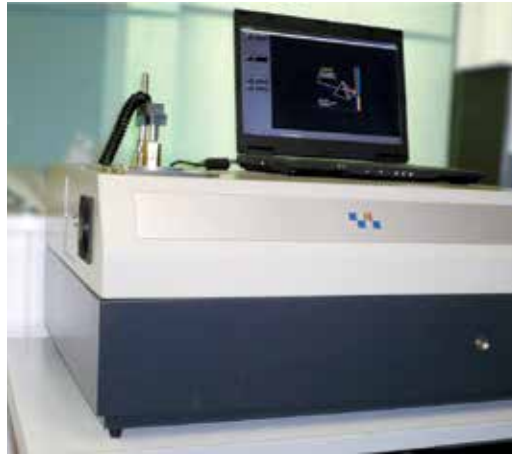

**PROTOTIPATRICE TRIDIMENSIONALE
THREE-DIMENSIONAL
PROTOTYPING MACHINE**

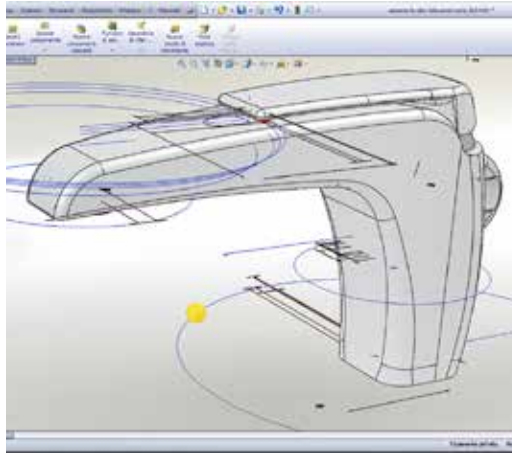

**MODELLO 3D
3D RENDER PROGRAM**

Deazione e progettazione sono supportate da una tecnologia innovativa di altissima qualità.
Design and projectual and practical creations are supported from a wide range of very innovative technologies

**RICERCA E SVILUPPO
RESEARCH AND DEVELOPMENT**





TÜV PROFICERT

CERTIFICATE

Management system as per
EN ISO 9001:2015

Evidence of conformity with the above standard(s) has been furnished and is certified in accordance with TÜV PROFICERT procedures for

REMER RUBINETTERIE S.p.A.
Via Leonardo da Vinci, 83
I - 20062 Cassano D'Adda (MI)

scope:

Design, production and sale of taps and fittings, hydraulic items, accessories and complements for bathroom and kitchen.

Scope: 18G02 (EA: 17/2)

Certificate registration No. **73 100 2281**

Certificate valid from 2017-04-11 to **2020-04-10**

Audit report No. 4320 5576

First certification 2008-03-07

O. Mahr
Darmstadt, 2017-04-11
Certification body of TÜV Hessen
Head of Certification body

PAGE 1 OF 1
This certification was conducted in accordance with the TÜV PROFICERT auditing and certification procedures and is subject to regular surveillance audits. Verifiable under: www.tuv.com. Original certificates contain a glued on hologram.
TÜV Technische Überwachung Hessen GmbH, Rüdelsheimer Str. 116, D-64285 Darmstadt, Tel. +49 6151 600331 Rev-GB-1301

TÜV PROFICERT

CERTIFICATE

Management system as per
EN ISO 14001:2015

Evidence of conformity with the above standard(s) has been furnished and is certified in accordance with TÜV PROFICERT procedures for

REMER RUBINETTERIE S.p.A.
Via Leonardo da Vinci, 83
I - 20062 Cassano D'Adda (MI)

scope:

Design, production and sale of taps and fittings, hydraulic items, accessories and complements for bathroom and kitchen.

Scope: 17R4 (EA: 17/2)

Certificate registration No. **73 104 2281**

Certificate valid from 2017-04-20 to **2020-04-19**

Audit report No. 4320 5576

First certification 2008-03-07

O. Mahr
Darmstadt, 2017-04-20
Certification body of TÜV Hessen
Head of Certification body

PAGE 1 OF 1
This certification was conducted in accordance with the TÜV PROFICERT auditing and certification procedures and is subject to regular surveillance audits. Verifiable under: www.tuv.com. Original certificates contain a glued on hologram.
TÜV Technische Überwachung Hessen GmbH, Rüdelsheimer Str. 116, D-64285 Darmstadt, Tel. +49 6151 600331 Rev-GB-1301

TÜV PROFICERT

CERTIFICATO

per il sistema di gestione secondo
EN ISO 9001:2015

La prova della conformità alla norma sopra indicata è stata fornita e viene documentata secondo le procedure TÜV PROFICERT per

REMER RUBINETTERIE S.p.A.
Via Leonardo da Vinci, 83
I - 20062 Cassano D'Adda (MI)

Campo di applicazione:

Progettazione, produzione e vendita di rubinetteria, articoli per idraulica, accessori e complementi per bagno e cucina

Scopo: 18G02 (EA: 17/2)

N° registrazione certificato **73 100 2281**

Certificato valido da 2017-04-11 a **2020-04-10**

Rapporto di Audit 4320 5576

Prima certificazione 2008-03-07

O. Mahr
Darmstadt, 2017-04-11
Organismo di Certificazione del TÜV Hessen
- Responsabile della certificazione -

PAGINA 1 DI 1
Questa certificazione è stata eseguita secondo la procedura TÜV PROFICERT per verifiche e certificazioni e viene periodicamente sorvegliata.
Verificabile sul sito www.tuv.com. I certificati originali contengono un ologramma collato.
TÜV Technische Überwachung Hessen GmbH, Rüdelsheimer Str. 116, D-64285 Darmstadt, Tel. +49 6151 600331 Rev-IT-1301

TÜV PROFICERT

CERTIFICATO

per il sistema di gestione secondo
EN ISO 14001:2015

La prova della conformità alla norma sopra indicata è stata fornita e viene documentata secondo le procedure TÜV PROFICERT per

REMER RUBINETTERIE S.p.A.
Via Leonardo da Vinci, 83
I - 20062 Cassano D'Adda (MI)

Campo di applicazione:

Progettazione, produzione e vendita di rubinetteria, articoli per idraulica, accessori e complementi per bagno e cucina

Scopo: 17R4 (EA: 17/2)

N° registrazione certificato **73 104 2281**

Certificato valido da 2017-04-20 a **2020-04-19**

Rapporto di Audit 4320 5576

Prima certificazione 2008-03-07

O. Mahr
Darmstadt, 2017-04-20
Organismo di Certificazione del TÜV Hessen
- Responsabile della certificazione -

PAGINA 1 DI 1
Questa certificazione è stata eseguita secondo la procedura TÜV PROFICERT per verifiche e certificazioni e viene periodicamente sorvegliata.
Verificabile sul sito www.tuv.com. I certificati originali contengono un ologramma collato.
TÜV Technische Überwachung Hessen GmbH, Rüdelsheimer Str. 116, D-64285 Darmstadt, Tel. +49 6151 600331 Rev-IT-1301

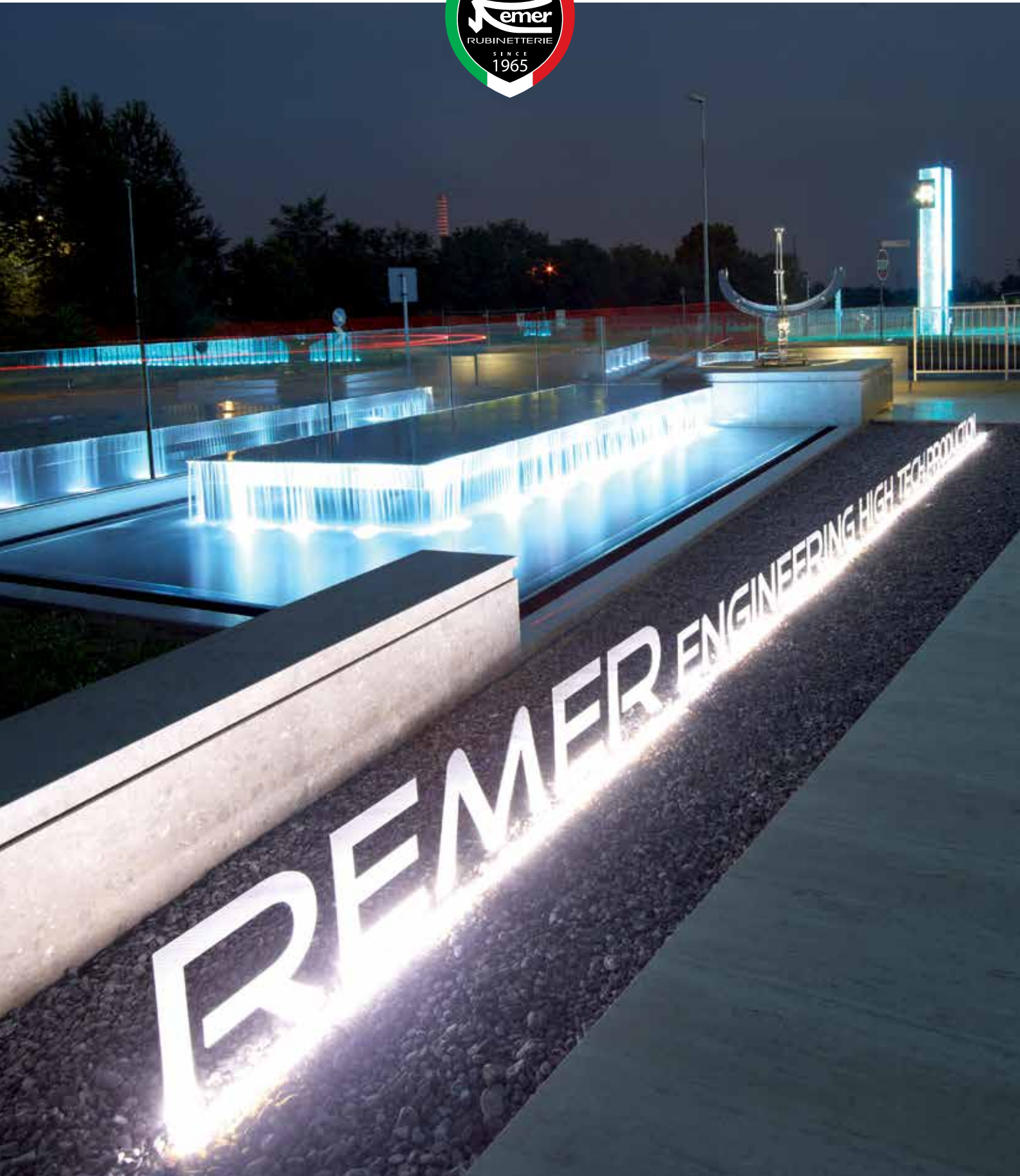



Grazie!
Thank you!

Condizioni generali di vendita

Accettazione ordini

La commissione è sempre subordinata all'approvazione della Casa Venditrice. Le condizioni di vendita si intendono accettate dal committente al momento del conferimento dell'ordine e con il ritiro del materiale.

Consegne e rese

La merce è resa franco deposito di partenza e viaggio a rischio e pericolo del committente. Il venditore si riserva di poter effettuare consegne parziali.

Spedizioni

Le quantità devono essere verificate all'atto del ricevimento ed eventuali discordanze vanno annotate sulla bolla di consegna mediante accettazione "con riserva". Eventuali spese aggiuntive per giacenze sono a carico del committente.

Imballaggio

L'imballaggio è effettuato con imballi standard ed eventualmente su pallets a carico del committente.

Termini di consegna

I termini di consegna, eventualmente indicati, sono sempre forniti a puro titolo indicativo e non vincolante.

Prezzi

I prezzi riportati nei listini non sono vincolanti. La Remer Rubinetterie S.p.A. si riserva la facoltà di variare i prezzi di vendita in qualsiasi momento senza nessun preavviso.

Pagamenti

L'eventuale ritardo del pagamento comporterà l'addebito di interessi al tasso corrente. La Remer Rubinetterie S.p.A. si riserva la facoltà di sospendere eventuali ordini in corso in presenza di pagamenti irregolari. Le contestazioni di qualsiasi valore o entità non danno diritto alla sospensione dei pagamenti.

Reclami

Non si accettano reclami o resi merce dopo 7 giorni dal ricevimento della stessa. I reclami devono pervenire entro i termini indicati tramite lettera raccomandata e via fax. Ogni reso deve essere preventivamente autorizzato dalla Remer Rubinetterie S.p.A. che fornirà istruzioni in merito.

Caratteristiche tecniche

La Remer Rubinetterie S.p.A. si riserva il diritto di effettuare modifiche tecniche ed estetiche sui prodotti, senza preavviso alla clientela.

Riservato dominio

I prodotti rimangono di proprietà della Remer Rubinetterie S.p.A. fino al totale pagamento del prezzo in conformità a quanto previsto dal C.C.

Responsabilità

La Remer Rubinetterie S.p.A. non fornisce garanzie circa l'impiego errato o inadatto dei propri prodotti. Qualora il materiale risultasse difettoso per vizi di fabbricazione riconosciuti a seguito di perizia, la Remer Rubinetterie S.p.A. si riserva di sostituirlo o accreditarne il valore senza che la propria responsabilità si possa estendere in nessun caso ad altri oneri.

Foro

Per qualsiasi controversia il Foro competente è quello di Milano.

Stampato nel mese di Agosto 2018.

Sale conditions

Orders acceptance

The order is always subject to approval by the seller.

Delivers

The goods are delivered Ex Works and travel at the buyer's own risk. The seller reserves the right to execute partial consignments.

Forwarding

The quantities must be checked on receipt of the goods and any complaint must be made to the carrier. Any additional cost applied by the carrier will be charged to the buyer.

Packing

The goods are packed in standard packing on pallets charged to the customer.

Delivery terms

The delivery terms are always given as information and they never have to be considered as binding.

Prices

The prices shown on price list are not binding. Remer Rubinetterie S.p.A. reserves the right to modify the sales prices in any time with no prior warning.

Payments

Interest at the current rate will be charged for any delays in payment. Remer Rubinetterie S.p.A. reserves the right to delete any order on hand if the payments are not correct. Any complaint of whatever type or value do not give the right to suspend payments.

Complaints

Complaints and returned goods cannot be accepted after a period of 7 days from the arrival of the goods. Complaints must be made by mean of a registered letter or by fax within the terms stated. Any return of the goods must be authorized in advance by Remer Rubinetterie S.p.A. with instructions about it.

Technical specifications

Remer Rubinetterie S.p.A. reserves the right to carry out technical and aesthetical changes without previous notice to customers.

Lien

The products remain the property of Remer Rubinetterie S.p.A. until the cost has been paid in full, in accordance with the provisions of the C.C.

Liability

Remer Rubinetterie S.p.A. does not provide a guarantee covering the incorrect or the inappropriate use of its products. If the material should be substandard owing to manufacturing faults which are technical inspections, Remer Rubinetterie S.p.A. reserves the right to replace the material or to credit the value to the buyer. However under no circumstance does the company's liability extend to the payment of direct or indirect charges for other things.

Competent Court of Law

For any controversy that may arise the competent court of law is the one of Milan.

Printed on August 2018.



Remer Rubinetterie S.p.A.
Via Leonardo da Vinci, 83
20062 Cassano d'Adda (MI) Italy
Tel. +39 0363 364 211
E-Mail: info@remer.eu
www.remer.eu

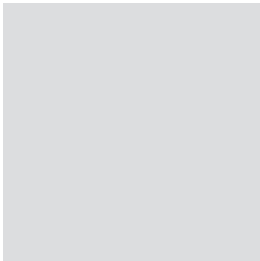
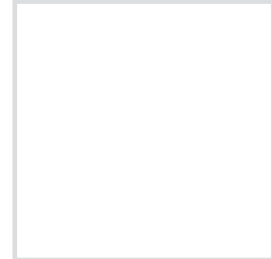

Ufficio Commerciale Italia:
Tel. 0363 364 333
Fax 0363 63 575
Export Commercial Department:
Tel. +39 0363 364 364
Fax +39 0363 364 300

